

## Industrial Wastewater Treatment of Food Industry Using Best Techniques

Mohamed Nazih Abdallah<sup>1</sup>, Walid Sayed Abdelhalim<sup>1</sup>,  
Hisham Sayed Abdelhalim<sup>2</sup>

<sup>1</sup>Housing and Building National Research Center / Environmental and Sanitary Engineering Department / Cairo / Egypt.

<sup>2</sup>Cairo University, Faculty of Engineering / Civil Engineering Department / Cairo / Egypt.

---

**Abstract:** Food processing industry wastewater poses pollution problems due to its high COD (Chemical Oxygen Demand) and BOD (Biochemical Oxygen Demand). Compared to other industrial sectors, food industry requires great amounts of water, since it is used throughout most of plant operations, such as production, cleaning, sanitizing, cooling and materials transport, among others. The wastewater streams with different levels of pollution load (low, medium and high contamination) are collected and treated in an on-site installation or in a municipal sewage treatment plant. Increasing food production will increase the volume of sewage and the cost of disposal for food processing plants and present difficult challenges for municipal wastewater treatment plant operators.

The production process includes five production lines were operating, chocolate cake line, three lines of different biscuits type, and ketchup line. The industry consumes about 141 m<sup>3</sup>/day for domestic water activities while the overall total wastewater discharges equal 120 m<sup>3</sup>/day and 70 m<sup>3</sup>/day for domestic wastewater and industrial wastewater respectively.

The main environmental problem of the industry is that the industrial wastewater resulting from the facility is not meeting the limits of the environmental regulations for the discharge of wastewater to the sewer network. Accordingly, the industry has to treat the wastewater prior to its discharge to the wastewater sanitary network. The main objectives of this study are management and control of liquid and solid wastes in the industry as well as selecting the different possible treatment trains for the wastewater prior to its discharge to the sewer system in order to protect the environment and to gain benefits as much as possible from the wasted materials and identify opportunities for introducing pollution prevention measures and best method for waste minimization as cleaner production system.

A treatability study and analysis was conducted for investigating the feasibility of each of identifying the different possible treatment trains, selecting the most suitable treatment train, and developing the basic design for the selected treatment train for the wastewater streams that need to be treated prior to its discharge to the sewer system. As well as treatment procedure through a bench scale model and treatability study was developed for the industrial wastewater streams of the industry to study the analysis of waste discharges and investigate the most appropriate treatment techniques using two proposed streams of techniques; physical-chemical treatment and physical-chemical treatment followed by biological treatment technique (Coagulation followed by Sedimentation) or using biological treatment.

Based on the analysis and treatability study of the alternative Physical Treatment by Gravity Settling, it is clear that the BOD and COD are still not complying with the regulatory limits for the discharge to the sewer system. Accordingly, equalization and gravity settling is not considered a feasible alternative for treatment of the industrial wastewater discharge. Moreover, based on the above calculations, mixing with industrial wastewater after equalization and gravity settling does not assist in complying with the regulatory limits. While through using Physicochemical Treatment by Coagulation and Sedimentation, it is resulted in reduction of COD and BOD by 81% and 85% respectively in the 24 hr composite sample. In the 48 hr sample, the reduction is 45% in the COD and 52% in BOD. Accordingly, the wastewater resulting after coagulation and sedimentation is complying with the discharge limits to the sewer system. As for the physical-chemical treatment, through coagulation and sedimentation, it has resulted in reduction of the wastewater pollutants below the discharge limits. Accordingly, a Dissolved Air Flotation (DAF) Unit would be considered a feasible alternative as it is used to remove suspended solids and oil and grease from industrial wastewater. The previous results indicated that the best process alternative is the coagulation/flocculation followed by Dissolved Air Flotation (DAF) gives high treatment efficiency of the wastewater. So, the recommended treatment scheme would be carried out using aeration tank and DAF unit. Accordingly, basic engineering design is conducted for this alternative.

**Keywords:** Food Industry, Chemical and Physical Treatment, Industrial Wastewater Treatment, Cleaner Production, Dissolved Air Flotation

---

### I. Introduction

The wastewater from industries varies so greatly in both flow and pollution strength. So, it is impossible to assign fixed values to their constituents. In general, industrial wastewaters may contain suspended, colloidal and dissolved (mineral and organic) solids. In addition, they may be either excessively acid or alkaline and may contain high or low concentrations of colored matter. These wastes may contain inert, organic or toxic materials and possibly pathogenic bacteria. These wastes may be discharged into the sewer system provided they have no adverse effect on treatment efficiency or undesirable effects on the sewer system. It may be necessary to pretreat the wastes prior to release to the municipal system or it is necessary to a fully treatment when the wastes will be discharged directly to surface or ground waters.

The development of industries and extensive urbanization means increased water consumption and pollution resulting from problems of waste disposal. Unfortunately, in most developing countries, effluent quality standards imposed by legislation (where they exist) are sometimes easily flouted. Industrial effluents are liquid wastes which are produced in the course of industrial activities. Over the years, the improper disposal of industrial effluents has been a major problem and a source of concern to both government and industrialist. In most cases the disposal or discharges of effluents, even when these are technologically and economically achievable for particular standards, do not always comply with pretreatment requirement and with applicable toxic pollutant effluent limitations or prohibitions. The consequence of these anomalies is a high degree of environmental pollution leading to serious health hazards[1].

Whereas the nature domestic wastewater is relatively constant, the extreme diversity of industrial effluents calls for an individual investigation for each type of industry and often entails the use of specific treatment processes. Therefore, a thorough understanding of the production processes and the system organization is fundamental. A long-term detailed survey is usually necessary before a conclusion on the pollution impact from an industry can be reached. Typical pollutants and BOD range for a variety of industrial wastes are given in Table-1. The values of typical concentration parameters (BOD5, COD, suspended solids) and pH for different industrial effluents are given in Table-2 [2].

**Table1: Wastewater characteristics for typical industries**

Industry	Principal pollutants	BOD5 mg/l
Dairy, milk processing	Carbohydrates, fats, proteins	1000-2500
Meat processing	SS, protein	200 -250
Poultry processing	SS, protein	100-2400
Bacon processing	SS, protein	900-1800
Sugar refining	SS, Carbohydrates	200-1700
Breweries	Carbohydrates, protein	500-1300
Canning fruit etc	SS, Carbohydrates	500-1200
Tanning	SS, protein, sulphide	250-1700 minimal
Electroplating	SS, Carbohydrates, heavy metals	800-1200
Laundry	SS, Carbohydrates, soaps, oils	250-1500
Chemical plant	SS, acidity, alkalinity	

SS: suspended solids

**Table1: Comparative strengths of wastewaters from industry**

Type of waste	BOD5mg/l	CODmg/l	SSmg/l	pH
<b>Apparel</b>				
Cotton	200-1000	400-1800	200	8-12
Wool scouring	2000-5000	2000-5000(a)	3000-30000	9-11
Wool composite	1	-	100	9-10
Tannery	1000-2000	2000-4000	2000-3000	11-12
Laundry	1600	2700	250-500	8-9
<b>Food</b>				
Brewery	850	1700	90	4-8
Distillery	7	10	Low	-
Dairy	600-1000	-	200-400	Acid
<b>Cannery</b>				
citrus	2000	-	7000	Acid
pea	570	-	130	Acid
Slaughterhouse	1500-2500	-	800	7
Potato processing	2000	3500	2500	11-13
Sugar beet	450-2000	600-3000	800-1500	7-8
Farm	1000-2000	-	1500-3000	7.5-8.5
Poultry	500-800	600-1050	450-800	6.5-9
<b>Materials</b>				
Pulp; sulfite	1400-1700	-	Variable	
Pulp; kraft	100-350	170-600	75-300	7-9.5
Paperboard	100-450	300-1400	40-100	
Strawboard	950	-	1350	
Coke oven	780	1650 (a)	70	7-11
Oil refinery	100-500	150-800	130-600	2-6

(a)=CODasKMnO<sub>4</sub> mgO<sub>2</sub>/l

Industrial wastewaters are considerably diverse in their nature, toxicity and treatability, and normally require pre-treatment before being discharged to sewer. Food processing in particular is very dissimilar to other types of industrial wastewater, being readily degradable and largely free from toxicity. However, it usually has high concentrations of biological oxygen demand (BOD) and suspended solid [3]. Compared to other industrial sectors, the food industry uses a much greater amount of water for each ton of product [4].

Industrial wastewater characteristics vary not only between the industries that generate them, but also within each industry. These characteristics are also much more diverse than domestic wastewater, which is usually qualitatively and quantitatively similar in its composition. On the contrary, industry produces large quantities of highly polluted wastewater containing toxic substances, organic and inorganic compounds such as: heavy metals, pesticides, phenols and derivatives thereof, aromatic and aliphatic hydrocarbons, halogenated compounds, etc., which are generally resistant to destruction by biological treatment methods. Food industry uses large amounts of water for many different purposes including cooling and cleaning, as a raw material, as sanitary water for food processing, for transportation, cooking and dissolving, as auxiliary water etc. In principle, the water used in the food industry may be used as process and cooling water or boiler feed water. As a consequence of diverse consumption, the amount and composition of food industry wastewaters varies considerably. Characteristics of the effluent consist of large amounts of suspended solids, nitrogen in several chemical forms, fats and oils, phosphorus, chlorides and organic matter[5].

Food and beverage industry is one of the major contributors to growth of all economies. In EU it constitutes the largest manufacturing sector in terms of turnover, value added and employment. However, the sector has been associated with various environmental issues including water usage and wastewater treatment. Food processing industry wastewater poses pollution problems due to its highCOD (Chemical Oxygen Demand) and BOD (Biochemical Oxygen Demand). Compared to other industrial sectors, food industry requires great amounts of water, since it is used throughout most of plant operations, such as production, cleaning, sanitizing, cooling and materials transport, among others. The wastewater streams with different levels of pollution load (low, medium and high contamination) are collected and treated in an on-site installation or in a municipal sewage treatment plant. Increasing food production will increase the volume of sewage and the cost of disposal for food processing plants and present difficult challenges for municipal wastewater treatment plant operators[6, 7]. Currently, in accordance with the legislation of the European Union introduced more stringent controls and rules concerning pollution of industrial wastewater [8, 9].

Increasing industrialization trend in the worldwide has resulted in the generation of industrial effluents in large quantities with high organic content, which if treated appropriately, can result in a significant source of energy. Food industry wastewater treatment by physicochemical method using Zinc Sulphate, Ferrous Sulphate and Ferric chloride has been reported. Where the reduction in COD has been obtained 60% with alum dose of 200 mg/L[10].

The food processing wastewater shows large variation in BOD/COD, total solids and suspended solids, oil and grease, starch, sugar, colour, preservatives, total nitrogen, total phosphates, chloride and sodium etc. This is due to the different additives used for different food products. Wastewater depicted COD/BOD and SS of 11220 mg/l, 6860 mg/L and 2210 mg/L respectively. From the studies it can be concluded that the food processing wastewater is easily amenable to physico-chemical treatment. The results obtained show that all the coagulants used individually or in combination with polyelectrolyte can remove moderate to high degree of chemical oxygen demand, biochemical oxygen demand and suspended solids from the food processing wastewater. Lime individually also acts as an efficient coagulant and moreover it is very cost effective. Addition 0.3 mg/L of anionic polyelectrolyte magnafloc to 200 mg/L of lime resulted in good SS, COD and BOD removals[11].

Anaerobic digestion seems to be the most suitable option for the treatment of high strength organic effluents. Anaerobic technology has improved significantly in the last few decades with the applications of differently configured high rate treatment processes, especially for the treatment of industrial wastewaters. High organic loading rates can be achieved at smaller footprints by using high rate anaerobic reactors for the treatment of industrial effluents[12]. A novel anaerobic-aerobic integrative baffled bioreactor supplied with porous burnt-coke particles was developed for the treatment of potato starch wastewater by Wang et al. (2009). This bioreactor was found to be effective for the removal of COD (88.4–98.7%) and NH<sub>3</sub>-N (50.4 to 82.3%), in high-strength starch wastewater[13].

Chocolate industry is among the most polluting of the food industries in regard to its large water consumption. Chocolate is one of the major industries causing water pollution. Considering the above stated implications an attempt has been made in the present project to evaluate one of the Effluent Treatment Plant (ETP) for Chocolate waste. Samples are collected from three points; Collection tank (CT), outflow of Anaerobic Contact Filter (ACF) and Secondary clarifier (SC) to evaluate the performance of Effluent Treatment Plant. Parameters analyzed for evaluation of performance of Effluent Treatment Plant are pH, COD, and BOD. The COD and BOD removal

efficiency of Effluent Treatment Plant were 98.7 and 99.4 % respectively. Hence its pH is also perform of 29.3% increase[14].

The main course of water pollution in the Alaro river is the direct discharge of food and beverages processing effluents. The impact of such effluents on the water quality was studied in detail by monitoring selected physicochemical parameters monthly between January 2003 and December 2007. The combined effluent was equally monitored. This study provided a detailed data on the quality of the effluent at the designated discharge point, upstream and downstream locations. The river is a recipient of effluents of poor quality. Some identified pollutants in the combined effluent are organic load, suspended solids, phosphate, nitrate and chloride which led to significant pollution of the Alaro river water. The receipt of the combined effluent has rendered the river unwholesome for certain beneficial purposes such as cooking, drinking, irrigation and aquatic life support. Thus the effluent has a profound impact on the physicochemical structure of the Alaro river and also affects the consumers of the river water. It is suggested that discharges from these industries should be given very high degree of treatment before final exist to the Alaro river[15].

Water usage in the food and drink industry is expressed either in volume of water consumed per finished product or per raw material processed. For slaughterhouses great variations in water usage per end-product were observed depending on the animal been slaughtered i.e. 1.5 -10 m<sup>3</sup>/t, 2.5-40 m<sup>3</sup>/t and 6-30 m<sup>3</sup>/t for pig, and cattle respectively. During the production of potato chips approximately 5 m<sup>3</sup> of water are consumed for each tone of raw potatoes processed. For olive oil production, less water is consumed if the two-phase centrifuge process is employed instead of the three-phase. Indicative values are 0.25 and 1.24 m<sup>3</sup>/t of olive oils. The manufacturing of cheese demands 1.05 – 3.6 m<sup>3</sup> of water per m<sup>3</sup> of milk processed while for the manufacturing of beer 2.5 – 6.4 hl of water are consumed for each hl of produced beer. Used water is eventually end up as wastewater except for the proportion which is used as a raw material e.g. for beer production. Although the pollution load depends on the type of industry, a common characteristic of all food and beverage sectors studied was the high values of organic content of wastewater. The highest values in terms of COD were observed for the wastewater occurring from the olive oil production process (400g/L) and from the cheese production process (77g/L) while high values were also observed for slaughterhouses (2-10g/L, considering blood is gathered separately), chip production process (4.3-9.3g/L) and beer industry (2-6g/L). Due to the high organic content, the biological processes are commonly applied for the treatment of wastewater of those industries. In particular, the application of anaerobic process is the predominant treatment process using UASB reactors[16].

## **II. Description Of The Food Industry Process**

The industry is a global leader in branded foods and beverages production in Egypt. The industry plant is operated into three shifts per day. The first shift from 8:00 am to 4:00 pm, the second shift from 4:00 pm to 12:00 am, while the third shift from 12:00 am to 8:00 am. The production process includes five production lines were operating, chocolate cake line, three lines of different biscuits type, and ketchup line.

## **III. Statement Of The Environmental Problem**

The food industry is committed to reducing environmental impacts of their activities, and to continuously improve their environmental performance and to meeting or exceeding the requirements of all applicable environmental laws and regulation. As conclusion of the lab analysis of the industrial wastewater effluent, the average values of pH, settleable solids, BOD, COD and oil and grease are above the limits of the Egyptian Environmental Regulation (Decree 44/2000), while values of TSS, settle-able solids, phosphorous and total nitrogen are within the limits. Accordingly, the industry has to treat the wastewater prior to its discharge to the wastewater sanitary network.

## **IV. Objectives Of The Study**

The main objectives of this study are management and control of liquid and solid wastes in the industry as well as selecting the different possible treatment trains for the wastewater prior to its discharge to the sewer system in order to protect the environment and to gain benefits as much as possible from the wasted materials and identify opportunities for introducing pollution prevention measures and best method for waste minimization as cleaner production system. The study is taking into account all types of waste production including wastewater and solid waste during the production processes activities.

The main objective is achieved via verifying some of sub-objectives such as reduce pollution load in terms of volume and concentration of wastewater through point source treatment, investigating the activities carried out in the industry and identifying the different wastewater discharge streams, identifying the characteristics and flow rates for each wastewater stream, selecting the wastewater streams that need to be treated prior to its discharge to the sewer system, identifying the different possible treatment trains for the wastewater, conducting

treatability analysis for investigating the feasibility of each of the identified trains, selecting the most suitable treatment train, and developing the basic design for the selected treatment train.

### **V. Materials And Methods**

There are two wastewater drainage networks and two end-of-pipe discharge points in the industry, one for industrial wastewater and the other for the domestic wastewater. The industrial wastewater end-of pipe discharge points include wastewater discharges from cleaning of equipment and production units, boiler blowdown, and the chiller open cycle discharged water, they all discharge at one manhole within the premises of the plant. The domestic wastewater discharge points include wastewater discharges from the wastewater generated from the washing of equipment at the end of the shifts, and wastewater discharges from all domestic sources within the industry, including toilets, restaurant, irrigation, cleaning, etc. As for the domestic wastewater, it is mixed with the industrial wastewater outside the premises of the plant prior to its discharge to the public sewer system.

Due to the great variation in the quality and quantity of wastewater produced, a continuous monitoring program was carried out to identify the quality and quantity of wastewater discharged. Samples have taken from the process and end-of-pipe industrial wastewater and other point of industrial wastewaters discharge during the process activities to perform a preliminary assessment of the environmental status of the facility.

To achieve the required objectives, the study is conducted following some steps and approaches as evaluate the current environmental conditions in the production and service units to determine the industry required to upgrade these units in order to reduce pollution load in the final effluent, data collection including the collection of information relevant to the different activities in the industry including qualitative and quantitative estimation of solid and liquid wastes, collecting composite wastewater samples from the end-of-pipe industrial effluent (the samples were analyzed by specialized laboratory and the results are used for selection of the most appropriate alternative schemes), check on the compliance with national environmental regulation and legislation and description of the existing environmental situation in the industry, and studying the different approaches for pollution prevention and suggesting possible end-of-pipe treatment modules.

#### **5.1 Water balance and Wastewater Discharge of the industry process:**

The production process includes five production lines were operating, chocolate cake line, three lines of different biscuits type, and ketchup line. The industry consumes about 141 m<sup>3</sup>/day for domestic water activities while the overall total wastewater discharges equal 120 m<sup>3</sup>/day and 70 m<sup>3</sup>/day for domestic wastewater and industrial wastewater respectively. There are two wastewater drainage networks and two end-of-pipe discharge points in the industry, one for industrial wastewater and the other for the domestic wastewater. The industrial wastewater end-of pipe discharge points include wastewater discharges from cleaning of equipment and production units, boiler blowdown, and the chiller open cycle discharged water, they all discharge at one manhole within the premises of the plant. The domestic wastewater discharge points include wastewater discharges from the wastewater generated from the washing of equipment at the end of the shifts, and wastewater discharges from all domestic sources within the industry, including toilets, restaurant, irrigation, cleaning, etc.

Based on the data provided by the plant on domestic water consumption the domestic wastewater flow rate is calculated assuming that 85% of the domestic water is discharged as wastewater. The following table illustrates the industrial wastewater discharges of the process.

**Table 1: Industrial Wastewater Discharges of the Process**

Wastewater Discharge Sources	Wastewater discharge m <sup>3</sup> /day
Washing of equipment and production units	19
Chiller water	47.5
Boiler blowdown	3.5
<b>Total</b>	<b>70</b>

**Table 2: Domestic Water Consumptions and Discharges**

Domestic Water Consumption (m3)		
1st shift	2ndshift	3rd shift
59	47	35
Total : 141 m3/day		
Domestic Wastewater discharge (m3)		
1st shift	2ndshift	3rd shift
50	40	30
Total : 120 m3/day		

According to the following table the relation between the domestic and industrial wastewater in each of the three shifts is presented. It is clear that in the three shifts the domestic wastewater is higher than the industrial wastewater.

**Table 3:** Relation between Domestic and Industrial Wastewater Discharge

Source	Wastewater discharge (m3)			
	1st shift	2 <sup>nd</sup> shift	3rd shift	Total per day
Domestic wastewater	50	40	30	120
Industrial wastewater	19	20	31	70
Total	69	60	61	190

### 5.2 Sampling and characterization of wastewater

The main objective of the analysis is to investigate the compliance of the wastewater with the limits for discharge to the public sewer system, and in case of noncompliance identify and evaluate alternatives for management of the wastewater to reach compliance.

For investigating the compliance of the discharged wastewater and identifying possible alternatives for its management, the sampling and analysis carried out for the wastewater in the industry was conducted as composite samples and analysis of the compiled industrial wastewater for each of the three operating shifts as well as grab samples and analysis of the mixed industrial and domestic wastewater in each of the three operating shifts. In addition, filtrations of the samples were carried out and the BOD and COD were analyzed before and after filtration. The analyses were carried out according to the Standard Methods for Examination of Water and Wastewater [17] and covered Temperature, pH, Chemical and Biological Oxygen Demand (COD and BOD), Total Dissolved and suspended solids (TDS and TSS), settle-able solids, and Oil & Grease.

Moreover, in order to investigate the effect of removing the suspended solids in the wastewater, through physical treatment, on the BOD and COD, filtration was carried out, and the BOD and COD were analyzed before and after filtration.

### 5.3 Treatability Study and Treatment Procedure

A treatability study and analysis was conducted for investigating the feasibility of each of identifying the different possible treatment trains, selecting the most suitable treatment train, and developing the basic design for the selected treatment train for the wastewater streams that need to be treated prior to its discharge to the sewer system. As well as treatment procedure through a bench scale model and treatability study was developed for the industrial wastewater streams of the industry to study the analysis of waste discharges and investigate the most appropriate treatment techniques using two proposed streams of techniques; physical-chemical treatment and physical-chemical treatment followed by biological treatment technique (Coagulation followed by Sedimentation) or using biological treatment.

## VI. Results And Discussion

### 6.1: Characterization of Liquid Wastewater and Assessment of Compliance of Industrial Wastewater

For investigating the compliance of the discharged wastewater, the sampling and analysis carried out for the wastewater in the industry was conducted as composite samples and analysis of the industrial wastewater with and without the Presence of the chiller water.

Composite sampling and analysis for the industrial wastewater was carried out for the production process includes five production lines were operating, chocolate cake line, three lines of different biscuits type, and ketchup line. The samples were taken for the collective industrial wastewater stream, which includes wastewater from cleaning of equipment and production lines, boilers blow down, and the chillers recycling water. The results of the analysis for the industrial wastewater for the three shifts are summarized in the following table and figures.

#### Analysis of Industrial Wastewater Characterizations with the Presence of the Chiller Water:

**Table 4:** Characteristics of the Industrial Wastewater Characterizations with the Presence of the Chiller Water

Parameter	Units	1st shift	2nd shift	3rd shift	Decree 44/2000 limits
pH		6.46	6.45	5.52	6-9.5
TSS	mg/l	560	200	305	800
Total Nitrogen	mg/l	16.8	11.2	11.6	100
Orthophosphorous	mg/l	0.4	0.242	0.298	25
Settleable solids	mg/l				
after 10 min		14.5	4.8	4	8
after 30 min		16	6	5.6	15
BOD	mg/l	2023	518	1980	600
COD	mg/l	2600	664	2450	1100
Oil and grease	mg/l	4.75	89.6	100.8	100

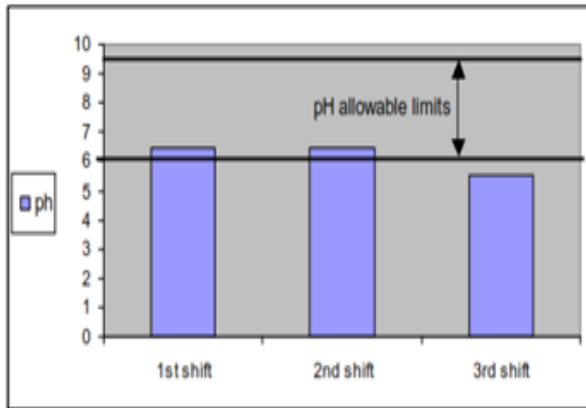

Figure 1: pH Analysis of Industrial Wastewater

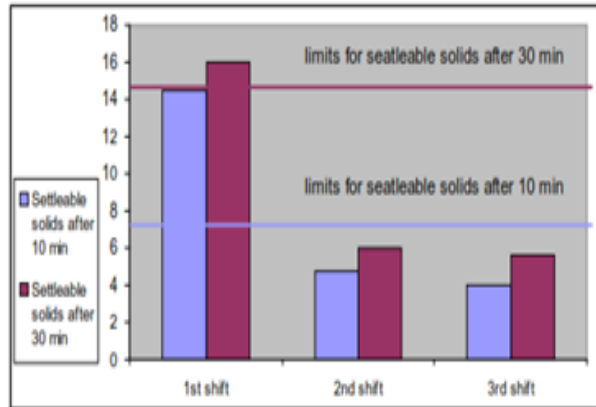

Figure 2: Settleable Solids Analysis of Industrial Wastewater

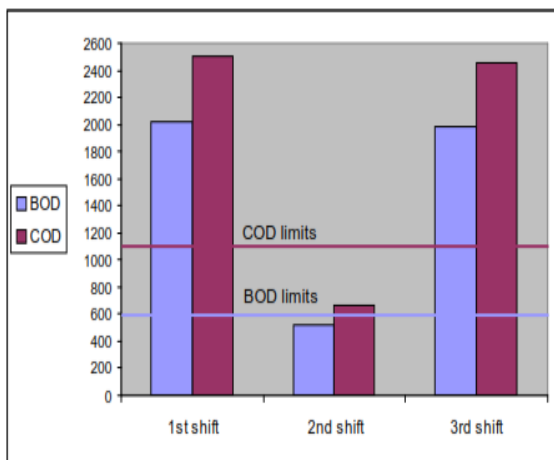

Figure 3: BOD & COD Analysis of Industrial Wastewater

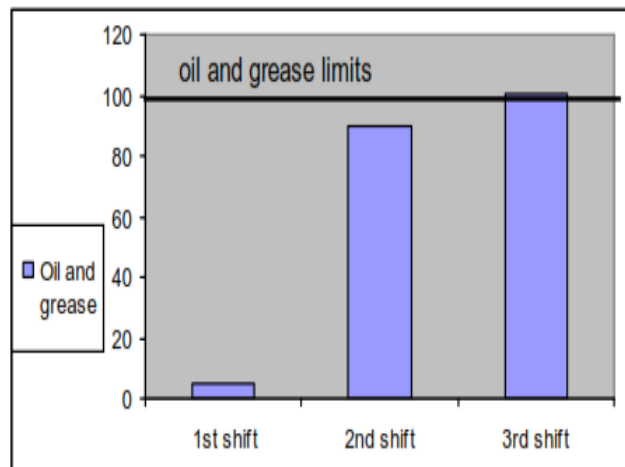

Figure 4: Oil and Grease Analysis of Industrial Wastewater

As results from the above analysis, it concluded that for pH analysis of the first two shifts is within the allowable limits, as for the third shift the pH is lower than the allowable limits. For the samples of the three shifts the pH is more towards the acidic range on the pH scale, for the settleable solids, samples from the second and third shift is complying with law limits, as for the first shift both the settleable solids after 10 min and 30 min are above the limits, for the BOD, the second shift is within the limits, while the first and third shifts are above the stipulated limits. Similarly for the COD, the second shift sample is within the limits while samples of the other two shifts are not complying, for oil and grease, samples of the first two shifts are within the stipulated limits, while sample for the third shift is not complying.

As a conclusion, the above results obtained from the analysis indicated that the average values of the pH, settleable solids, BOD, COD and oil and grease are above the limits of Decree 44/2000, while the values of the other parameters are within the limits, and accordingly cannot be discharged directly to the sewer network.

**Analysis of Industrial Wastewater Characterizations without the Presence of the Chiller Water:**

In case the chiller water cycle is fixed and converted to a close loop cycle, water will not be discharged from the chiller. The following table presents the results for calculations of BOD and COD concentration in the industrial wastewater after the removal of the chiller water.

**Table 5: Industrial Wastewater calculated BOD&COD after Chiller Water Removal**

Parameter	Units	1st shift	2nd shift	3rd shift	Decree 44/2000 limits
BOD	mg/l	7642	1554	5516	600
COD	mg/l	9822	1992	6825	1100

From the table above, it is clear that the concentration of the pollutants has increased in the industrial wastewater after the removal of the chiller water, and accordingly it is not complying with the limits and cannot be discharged directly to the sewer system.

### 6.2: Treatability Study and Identification of Possible Treatment Schemes

Alternatives for management and treatment of the discharged industrial wastewater to the limits of the Egyptian Environmental Regulation (Decree 44/2000) will be identified and assessed to investigate their feasibility from environmental and technical perspectives. Special attention will be given to low cost alternatives due to the limited budget allocated by industry for the wastewater management.

Pollutants in the domestic wastewater are expected to be lower than that of the industrial wastewater, accordingly mixing of the industrial and domestic wastewater is expected to dilute the pollutants discharged from the industrial wastewater. According to the laboratory analysis carried out for the mixed wastewater stream, it is clear that the pollutants concentration has decreased but it is still not complying with the regulatory discharge limits.

As stated above, the non-complying parameters for the industrial wastewater are the pH, settleable solids, BOD, COD and oil and grease. After mixing with the domestic wastewater, the same parameters remained non-complying except for the oil and grease.

**Table 6:** Analysis of Grab Samples from Mixed Industrial and Domestic Wastewater

Parameter	Units	1st shift	2nd shift	3rd shift	Decree 44/2000 limits
pH		6.1	6.55	5.83	6-9.5
TSS	mg/l	567	299	700	800
Total Nitrogen	mg/l	33.8	12.6	25.2	100
Orthophosphorous	mg/l	0.622	0.222	0.535	25
Settleable solids	mg/l				
after 10 min	mg/l	81.6	6	8.2	8
after 30 min	mg/l	81.6	8	12	15
BOD	mg/l	1152	462	1851	600
COD	mg/l	1519	517	2200	1100
Oil and grease	mg/l	20.8	10.4	54.8	100

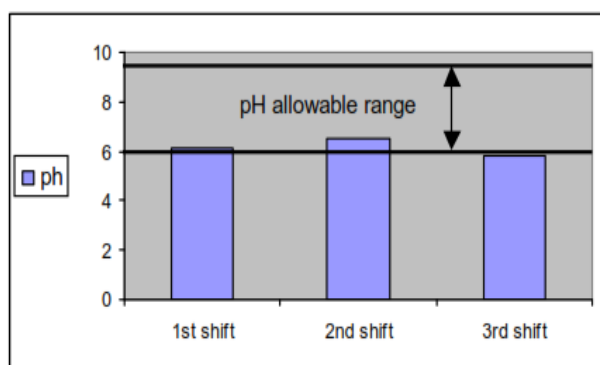

**Figure 5:** pH Analysis of Industrial and Domestic Wastewater

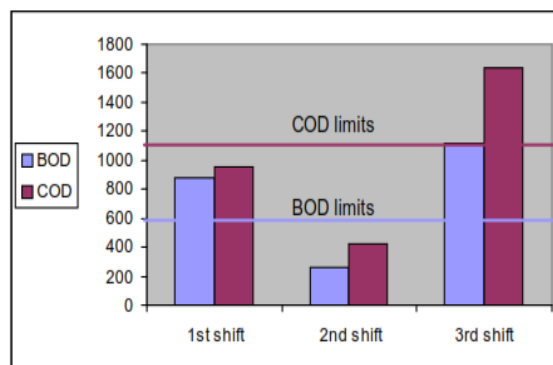

**Figure 6:** BOD & COD Analysis of Industrial and Domestic Wastewater

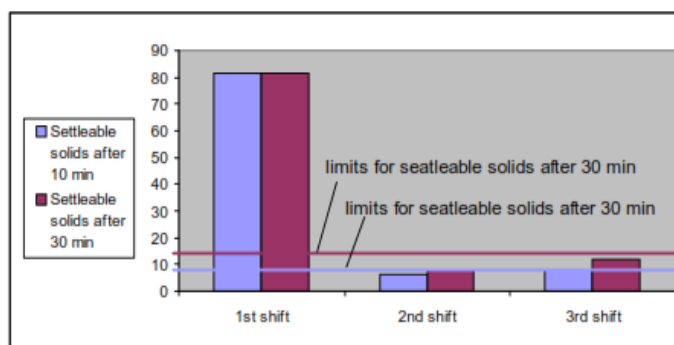

**Figure 7:** Settleable Solids Analysis of Industrial and Domestic Wastewater

As results from the above analysis, it concluded that for pH, as with the industrial wastewater, the pH in the third shift is still not complying, for settleable solids, noncompliance has been witnessed in the first shift for the industrial wastewater, and the noncompliance of the same shift remained after the mixing with the domestic wastewater, for both the BOD and COD, the second shift is within the limits, while the first and third shifts are above the stipulated limits, for the industrial wastewater before mixing with the domestic wastewater. After mixing, the noncompliance of the two shifts remained. But as for the oil and grease, it is the only non-



complying parameter that has reached compliance after mixing with the domestic wastewater. Accordingly, it is clear that the direct mixing of the domestic wastewater with the industrial wastewater would not be considered a feasible alternative as the mixed wastewater is not complying with the discharge limits of Decree 44/2000. There are two treatment schemes identified based on the characteristics of the wastewater. The first scheme is physical-chemical treatment, while the second is by physical-chemical treatment followed by biological treatment.

**First Scheme: Physical-Chemical Treatment**

Physical/chemical treatments are techniques to remove the coarse fraction from the wastewater, and accordingly reduce the concentration of pollutants.

Through the physical-chemical treatment, chemical coagulants are added to the wastewater to coagulate the fine suspended particulates, and facilitate their removal from the wastewater. The removal process can be through sedimentation or flotation. In the sedimentation, the coagulated suspended particulates are allowed to settle, and the participated suspended solids are removed as sludge. In the floatation, a fine gas (usually air) is introduced in bubbles to the liquid phase, and the bubbles attach to the particulate matter and rise to the surface. Once the particulates have been floated to the surface, they can be collected by skimming. The floatation also facilitates the rising of particles with lower density than the wastewater, such as oil and grease. Thus, since the physical-chemical treatment main objective is removing the suspended solids in the wastewater, the filtration of the wastewater carried out in the laboratory where the suspended solids were removed is used to give an indication on the effect of the physical chemical treatment. Based on the laboratory results, the filtration did not result in reduction of the BOD and COD to reach the regulatory discharge limits.

**Table 7: Effect of Filtration on BOD & COD**

<b>Industrial Wastewater after Filtration</b>					
Parameter	Units	1st shift	2nd shift	3rd shift	Decree 44/2000 limits
BOD	mg/l	1034	278	1984	600
COD	mg/l	1280	432	2300	1100
<b>Mixed Industrial and Domestic Wastewater after Filtration</b>					
Parameter	Units	1st shift	2nd shift	3rd shift	Decree 44/2000 limits
BOD	mg/l	882	262	1120	600
COD	mg/l	955	418	1635	1100

Although the filtration is only an indication of the effect of the physical chemical treatment, however since the filtration did not results in decreasing the pollutants in the wastewater to reach compliance. It is not recommended to further investigate the physical-chemical treatment.

**Physical Treatment by Gravity Settling:** Most of the oil and grease in the industrial wastewater is not free but is combined with the solids. Accordingly the removal of the oil and grease together with the associated suspended solids was carried out through sedimentation rather than floatation.

Gravity sedimentation was performed to remove the settleable solids as well as part of the suspended solids, gravity settling after 24 hrs has resulted in both of the 24hr composite sample and the 48 hr composite sample has resulted in 100% removal of settleable solids and 3% removal of suspended solids in the 24hr sample and 27% in the 48 hr sample. However, BOD and COD after removal are still not complying with the regulatory limits for the discharge to the sewer system.

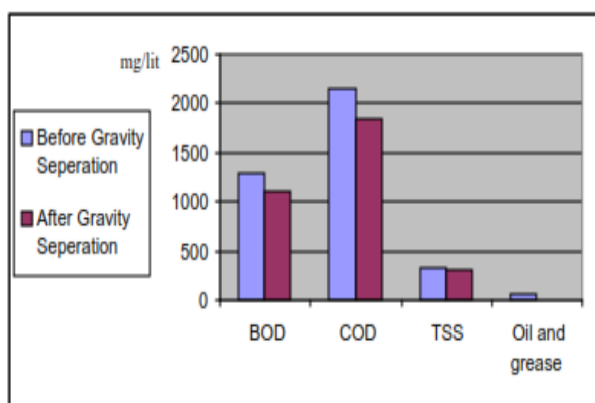

**Figure 8: Effect of Gravity Separation on the 24 hr Composite Sample**

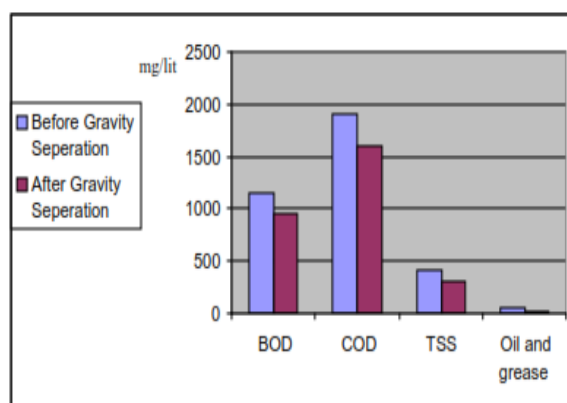

**Figure 9: Effect of Gravity Separation on the 48 hr Composite Sample**

Based on the above it is clear that the BOD and COD are still not complying with the regulatory limits for the discharge to the sewer system. Accordingly, equalization and gravity settling is not considered a feasible alternative for treatment of the industrial wastewater discharge. Moreover, based on the above calculations, mixing with industrial wastewater after equalization and gravity settling does not assist in complying with the regulatory limits.

**Physicochemical Treatment by Coagulation and Sedimentation:** Chemical coagulant is used to break the suspension and allow the settling of the suspended solids with associated oil and grease. Accordingly, ferrous sulphates were added to the industrial wastewater after adjusting its pH with 0.4 gram NaOH.

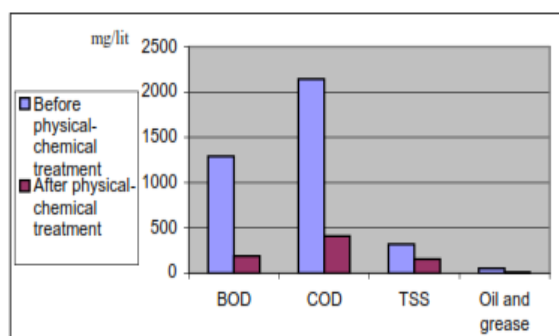

**Figure 10:** Effect of Physical-Chemical Treatment on the 24 hr Composite Sample

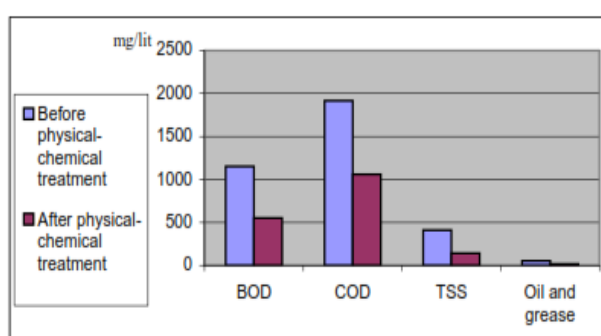

**Figure 11:** Effect of Physical-Chemical Treatment on the 48 hr Composite Sample

The physico-chemical treatment resulted in reduction of COD and BOD by 81% and 85% respectively in the 24 hr composite sample. In the 48 hr sample, the reduction is 45% in the COD and 52% in BOD. Accordingly, the wastewater resulting after coagulation and sedimentation is complying with the discharge limits to the sewer system.

The amount of ferrous sulphates ( $\text{FeSO}_4 \cdot 7\text{H}_2\text{O}$ ) used is  $0.067 \text{ kg/m}^3$ , accordingly the daily amount needed from ferrous sulphates will be about 6.7 kg. This alternative will entail an equalization tank, a mixing tank, sedimentation tank as well as a filter press.

### **Second Scheme: Physical-Chemical Treatment followed by Biological Treatment**

The discharged industrial wastewater is biodegradable as it is high inorganic content. The BOD/COD ratio in the three shifts is higher than 0.7 indicating high biodegradability of the wastewater. The suggested alternative treatment trains to be investigated through the treatability analysis are oil and grease removal and biological treatment. These trains will be carried out in phases; the first phase will entail the investigations of the oil and grease removal, while the second would entail biological treatment. Based on the result of the first phase, decision will be taken whether to proceed to the second stage.

#### ▪ **First Train : Oil and grease removal and Equalization**

Oil and grease concentration in the industrial wastewater analysis is high and accordingly by the removal of the oil and grease other non-complying parameters such as the BOD and COD will decrease. Therefore, this train would entail equalization of the industrial wastewater and removal of the oil and grease. Accordingly, a composite sample is suggested to be taken from the industrial wastewater stream over a period of 24hrs to give an indication of the equalization carried over 24 hrs.

The analysis show that the quality of the industrial wastewater varies greatly from one shift to the other based on the production and cleaning activities carried out, the time schedule of these activities being variable. Moreover, the quantity of the industrial wastewater discharged per day is small,  $17.5 \text{ m}^3/\text{day}$ , and accordingly the equalization tank for 24 hrs will be approximately  $21 \text{ m}^3$ . Therefore, it is suggested that the equalization be over 24 hours rather than per shift.

Based on the results of the proposed treatability analysis after oil and grease removal is would be decided whether to discharge the industrial wastewater directly or mix it in the manhole with the domestic wastewater before discharge. However, if the treatability results prove that the effect of oil and grease removal is minimal and did not help in reaching compliance with regulatory limits, the second treatment train will be investigated.

#### ▪ **Second Train: Biological Treatment**

Based on the analysis of the industrial wastewater, it is clear that it is biodegradable, since the BOD/COD is above 0.7 in the three shifts. In the treatability, both the biological treatment through simple aeration and

activated sludge will be investigated for composite samples of the industrial wastewater. The results of the treatability analysis, whether for the first or second train, will assist in identifying the specification and capacity of the needed treatment unit, and accordingly developing the basic design and identifying the estimated cost. Moreover, prior to the treatability analysis of the industry should work on adopting housekeeping practices that will assist in decreasing the concentration of pollutants in the industrial wastewater. Examples of such practices are:

- Ensuring that all solid waste and powder in the production units is vacuum cleaned and disposed as solid waste rather than being swept with the industrial wastewater.
- During maintenance of equipment, the used oil should be collected and discharged separately, and not discharged with the wastewater.

As for the physical-chemical treatment, through coagulation and sedimentation, it has resulted in reduction of the wastewater pollutants below the discharge limits. Accordingly, a Dissolved Air Flotation (DAF) Unit would be considered a feasible alternative as it is used to remove suspended solids and oil and grease from industrial wastewater.

The recommended treatment scheme would be carried out using aeration tank and DAF unit. Figure (8) below illustrates the proposed treatment schemes.

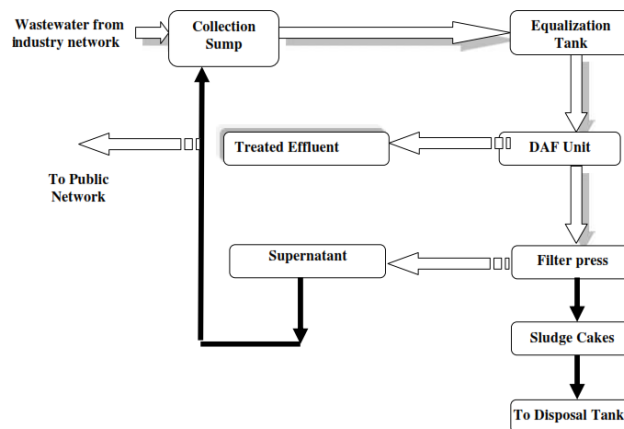

**Figure 12:** The Proposed Treatment Schemes

### **6.3: The engineering design and cost analysis for proposed alternatives**

The previous results indicated that the best process alternative is the coagulation/flocculation followed by Dissolved Air Flotation (DAF) gives high treatment efficiency of the wastewater. Accordingly, basic engineering design is conducted for this alternative. The suggested treatment sequence of the end of pipe effluent wastewater from the industry, as shown in figure 12, shall comprise the following:

**Collection Sump:** The wastewater from the gravity sewers inside the factory is collected in underground Collection Sump which contains two Submersible Pumps to discharge the collected wastewater to the Equalizing Tank.

**Equalizing and Aeration Tank:** The wastewater discharge from the collection sump is collected in new Equalizing Tank to adsorb any fluctuations in the influent flow-rate or characteristics, so that downstream treatment plant operates at a equalized wastewater flow.

**Diffused Flotation Unit "DAF Unit":** Equalized Wastewater is pumped at average flow by equalizing tank duty/standby submersible pumps to the treatment plant. The treatment starts with the pipe flocculator, where the waste is chemically conditioned by dosing of flocculant and coagulant to enable colloidal suspended matter to be removed from the wastewater. This process takes place in the pipe flocculator to perform proper mixing of chemicals.

At the end of the flocculator the pretreated wastewater is mixed with a part of the very fine dispersed air / recycle – water-flow-mixture. The other part which recycles water flows directly in the mixing zone of the flotation tank where pressure is reduced in a nozzle. This results in the formation of finest air bubbles, which stick to the particles and flocks and then floats. The produced fine air bubbles stick to the flocks formed in the flocculator, which causes buoyancy of the unwanted contents. This results in the floated material to be gathered in a sum layer at the surface of the solution.

Suspended material in the wastewater is floated and discharged by means of fine air bubbles during flotation process.

Wastewater is replenished with fine air bubbles in that way that treated wastewater from the flotation tank is led to a centrifugal pump as return water (recycle flow). In this pump, this works under pressure, the absorbing air dissolves.

Clear water produced from the DAF unit is further neutralized by dosing acid to meet the required PH disposal range.

Sludge Treatment: Floated sludge transferred from DAF unit into a sludge compartment integrated to the DAF unit. Sludge then gravitates and collects into a sludge collecting tank to place underneath the DAF unit. From this sludge collecting tank, the Sludge is pumped by duty/ standby progressive cavity eccentric helical pumps and fed to the dewatering system. Prior to entering the dewatering system, sludge is conditioned by dosing polyelectrolyte solution and then passed through an in-line static mixer to perform homogeneity. Dewatering is affected using recessed plate filter press. After each batch, the filtering plates are manually shifted and dewatered sludge falls down into a suitable sludge collection skip for further disposal. The filtrate water from the filter press is directed to public sewer.

- a) **Collection Sump:** this depend on one cylindrical tanks with volume 2 m<sup>3</sup> and retention time 40 minutes supported by Two submersible pumps (5m<sup>3</sup>/h/each)
- b) **Equalization and Aeration Tank:** this depend on one concrete rectangular tank with volume 100 m<sup>3</sup> supported by Two submersible pumps (5m<sup>3</sup>/h/each) and Diffused Air Supply system (Blower + Diffused Nozzles) with capacity 120 m<sup>3</sup>/h and head 350 mbar.
- c) **DAF Unit:** Steel unit with total capacity of 5m<sup>3</sup>/hr includes pipe flocculator, air supply system; compressor, air vessel, recirculation pumps, pipe connection, valves, fittings, alum and lime dosing system, and all needed accessories
- d) **Sludge Treatment Sludge Dewatering Unit:** Sludge and scum from the DAF Unit shall be passed to the sludge collection sump. The sump shall be circular concret with volume not less than 3 m<sup>3</sup>. The sump shall be equipped with two submersible pumps each with flow 3.0 m<sup>3</sup>/hr one working and the second is standby. The sludge pumps shall be pumped the raw sludge to the filter press with capacity of 231 kg/day. the dewatered outlet sludge should contain a minimum of 16 – 20 %. The following table illustrates the cost assessment for recommended industrial wastewater treatment system

**Table 8:** Cost Assessment for Recommended Industrial Wastewater Treatment System

Unit	Cost (Egyptian Pound)
Collection Sump	30,000
Equalization Tank	150,000
DAF Unit	220,000
Chemical system	55,000
Sludge Collection Sump	15,000
Dewatering Unit	170,000
Measuring and control instruments	50,000
Connecting Pipes and valves for all plant	10,000
<b>Total Cost</b>	<b>700,000</b>

The following figures illustrate the basic engineering drawings for the best process alternative.

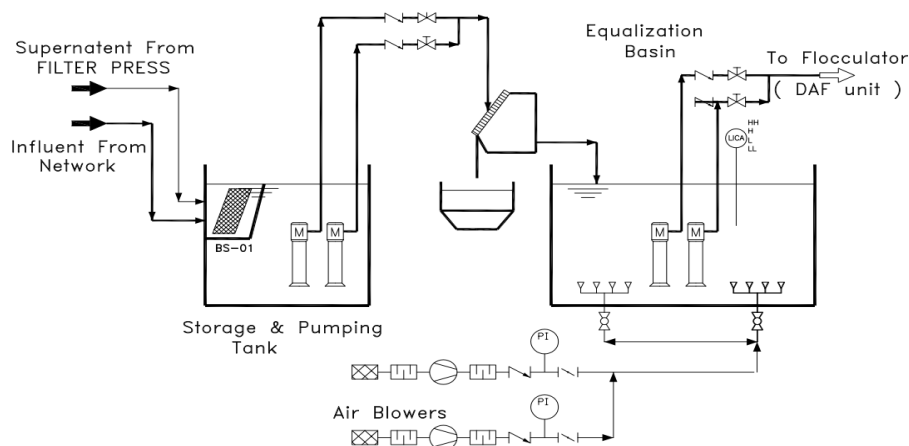

**Figure 13a:** The Suggested Treatment Process - Part1

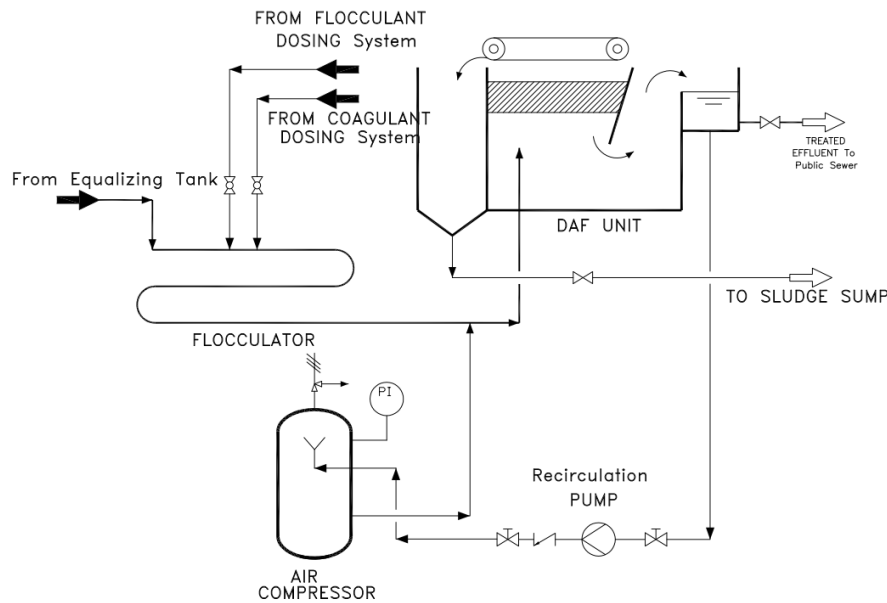

Figure 13b: The suggested Treatment Process – Part2

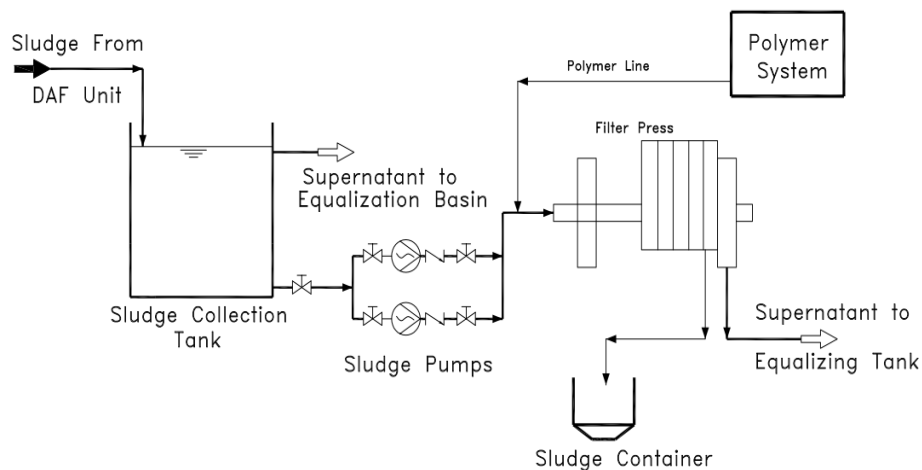

Figure 13c: The suggested Treatment Process – Part3

## VII. Conclusion And Assessment Of The Treatment Alternatives

Alternatives for management and treatment of the discharged industrial wastewater to the limits of the Egyptian Environmental Regulation (Decree 44/2000) will be identified and assessed to investigate their feasibility from environmental and technical perspectives. Special attention will be given to low cost alternatives due to the limited budget allocated by industry for the wastewater management.

Pollutants in the domestic wastewater are expected to be lower than that of the industrial wastewater, accordingly mixing of the industrial and domestic wastewater is expected to dilute the pollutants discharged from the industrial wastewater. According to the laboratory analysis carried out for the mixed wastewater stream, it is clear that the pollutants concentration has decreased but it is still not complying with the regulatory discharge limits. As concluded from the treatability study, the non-complying parameters for the industrial wastewater are the pH, settleable solids, BOD, COD and oil and grease. After mixing with the domestic wastewater, the same parameters remained non-complying except for the oil and grease.

Based on the analysis and treatability study of the alternative Physical Treatment by Gravity Settling, it is clear that the BOD and COD are still not complying with the regulatory limits for the discharge to the sewer system. Accordingly, equalization and gravity settling is not considered a feasible alternative for treatment of the industrial wastewater discharge. Moreover, based on the above calculations, mixing with industrial wastewater after equalization and gravity settling does not assist in complying with the regulatory limits. While through using Physicochemical Treatment by Coagulation and Sedimentation, it is resulted in reduction of COD and BOD by 81% and 85% respectively in the 24 hr composite sample. In the 48 hr sample, the reduction is 45% in

the COD and 52% in BOD. Accordingly, the wastewater resulting after coagulation and sedimentation is complying with the discharge limits to the sewer system.

As for the physical-chemical treatment, through coagulation and sedimentation, it has resulted in reduction of the wastewater pollutants below the discharge limits. Accordingly, a Dissolved Air Flotation (DAF) Unit would be considered a feasible alternative as it is used to remove suspended solids and oil and grease from industrial wastewater. The previous results indicated that the best process alternative is the coagulation/flocculation followed by Dissolved Air Flotation (DAF) gives high treatment efficiency of the wastewater. So, the recommended treatment scheme would be carried out using aeration tank and DAF unit. Accordingly, basic engineering design is conducted for this alternative.

A comparison of the proposed treatment alternatives is carried out in Table (8).

**Table8:** Comparison of the proposed treatment alternatives

Treatment Methods	Components	Financial Aspects	Technical Aspects
Dissolved Air Flotation (DAF)	- Aeration tank DAF unit - Filter press	Cost of aeration tank, DAF unit and filter press are approximately EGP 900,000 - 1,200,000	Completely automated and will reduce both free oil and grease and suspended particles
Biological Treatment Unit	- Aeration tank - Anaerobic fermentation tank of capacity approximately 300 m <sup>3</sup> - Sludge perpetration tank - Thickener	Cost of the unit is approximately EGP 1,500,000	Effect of the oil and grease available in an emulsion form, needs to be further investigated as it can negatively impact the biological treatment
Physical and Chemical Treatment in Tanks	- Equalization tank capacity 120 m <sup>3</sup> - Mixing tank and lamella settler tanks (each 3m*3m) - Chemical dosing pumps - Filter press or centrifuge	Cost of the unit is approximately EGP 600,000- 800,000	Operation is not fully automatic and requires skilled labor

### References

- [1]. Emmanuel A. Echiegu\* Jacob T. Liberty(2013)., "Effluents Characteristics of Some Selected Food Processing Industries in Enugu and Anambra States of Nigeria". Journal of Environment and Earth Science.Vol. 3, No.9.
- [2]. Wang & Howard(2004)."Handbook of Industrial and Hazardous Wastes Treatment".USA.
- [3]. Gray, N. F.(2005). "Water Technology: An Introduction for Environmental Scientists and Engineers".Oxford : Elsevier Butterworth-Heinemann.
- [4]. Mavrov, V., and Beleires, E. (2000). "Reduction of Water Consumption and Wastewater Quantities in The Food Industry by Water Recycling using Membrane Processes". Desalination; 131, 75-86.
- [5]. DorotaKrzemińska, Ewa Neczaj1, Gabriel Borowski (2005). "Advanced Oxidation Processes For Food Industrial Wastewater Decontamination".Journal of Ecological Engineering. Volume 16, Issue 2, Apr. 2015, pages 61–71. DOI: 10.12911/22998993/1858.
- [6]. Mavrov V., Belieres E. (2000). "Reduction of water consumption and wastewater quantities in the food industry by water recycling using membrane processes". Desalination, 131, 75–86.
- [7]. Cicek N. (2003). "A review of membrane bioreactors and their potential application in the treatment of agricultural wastewater". CSBE, 43, 37–49.
- [8]. Marcucci M., Ciardelli G., Matteucci A., Ranieri L., Russo M. (2002). Experimental campaigns on textile wastewater for reuse by means of different membrane processes. Desalination, 149 (1-3), 137–143.
- [9]. Mason T.J. (2000). Large scale sonochemical processing: aspiration and actuality. Ultrason.Sonochem., 7(4), 145–149.
- [10]. 10 - R. Mehrotra, B. K. Srivastava, and S. Prasad (1995)."Third International Conference on Appropriate wastemanagement technologies for developing countries, Nagpur. 25-26, 607-612.
- [11]. Vanerkar A. P., Sanjeev Satyanarayan (2013). "Treatment of Food Processing Industry Wastewater by a Coagulation/ Flocculation Process".International Journal of Chemical and Physical Sciences. ISSN:2319-6602. Vol. 2,63-72.
- [12]. Dereli, R.K.; Ersahin, M.E.; Ozgun, H.; Ozturk, I. & Aydin, A.F. (2010). Applicability of Anaerobic Digestion Model No.1 (ADM1) for a Specific Industrial Wastewater: Opium alkaloid effluents. Chemical Engineering Journal, 165, 1, 89-94
- [13]. Wang, R.; Wang, Y.; Ma, G.; He, Y. & Zhao, Y. (2009). "Efficiency of porous burnt-coke carrier on treatment of potato starch wastewater with an anaerobic-aerobic bioreactor".Chemical Engineering Journal, 148, 35–40.
- [14]. Akhilesh Kumar Patel, Shradha Patel, AasfaTabassum and Nikhil RanjanJha (2016).""Effluent Treatment Plant of Chocolate Industry- A Case Study".International Journal of Scientific Engineering and Applied Science. Volume-2, Issue-3, 181-186.
- [15]. AyodeleRotimilpeaiyeda\* and Percy ChuksOnianwa (2011). "Pollution Effect Of Food And Beverages Effluents On The Alaro River In Ibadan City, Nigeria". Bull. Chemical Society of Ethiopia.ISSN 1011-3924. 25(3), 347-360.
- [16]. Katerina Valta, TatjanaKosanovic, Dimitris Malamis, Konstantinos Moustakas, Maria Loizidou (2015). "Overview of water usage and wastewater management in the food and beverage industry".Desalination and Water Treatment. Volume 53, Issue 12,3335–3347.
- [17]. APHA, AWWA, WEF (2012). "Standard Methods for the Examination of Water and Wastewater". (22nd edition) Washington.