

High Rise Buildings with Combustible Exterior Wall Assemblies: The Optimum Size of Cavity (Gap) between the Wall and the Cladding.

Mousa Al-Dghaimat^{1*}, Awad Saad¹, Osama Abuzeid²
¹(Faculty of Architecture, Sudan University for Science & Technology, Sudan)
²(Professor, School of Engineering, The University of Jordan, Jordan)

ABSTRACT: This paper aims at presenting a novel model of Aluminium Composite Panels (ACPs) cladding system, nominally optimization of the air gap between the external wall of the high-rise buildings and the ACPs used for cladding.

To find the ideal gap, a simulated fire experiment was conducted on the new model using Grasshopper and Galapagos programs. The integrated novel model of ACPs proposed changes in material used also, like wet and hot insulations using special latest products like Fenomastic hygiene emulsion paint.

The input parameters for the algorithm were used to investigate validity of the proposed model are the following: -Initial fire temperature, facade material elements, facade elements properties, elements fire resistance and time.

As the result of the optimal value for the air gap from Evolutionary Algorithms (EA) simulation test is 11.1 cm, which is the optimal thickness of the air gap after testing and developing the genome generation using several simulation applications.

This finding and result will contribute to improve and enhance the behaviour of the fire flame in high-rise buildings, in addition to eliminate the fire risk for the habitant's life in the high levels of towers and conserve the environmental periphery including neighbour buildings, human beings, vehicles and all other equipment and materials.

KEYWORDS -Aluminium Composite Panels (ACPs), Optimization Gap depth, Fire Flame, Galapagos.

Date of Submission: 22-02-2023

Date of Acceptance: 05-03-2023

1. INTRODUCTION

In architecture and civil engineering, a lot of research carried out in the last two decade relating to the external cladding systems in general and to the depth of the gap particularly. It was found that the external facade of a building represents one of the most complex and expensive parts of such a construction project, sometimes accounting for up to 25% of the total cost. They must achieve multiple objectives of benefit to the building's occupants, maximising positive traits, such as the sustainability and aesthetics of the building, while minimising negative traits, such as the build-up of condensation in the walls or the overall fire risk of the building. These objectives are not independent, and improving one objective (e.g., improving a facade's moisture control) may require a trade-off in another (e.g., its ability to limit the spread of fire) [1].

Fires spreading due to a building cladding has risen to a global average of 4.8 fires per annum. "Fig.1" showing fire incidents worldwide every five years from 1990–2019.

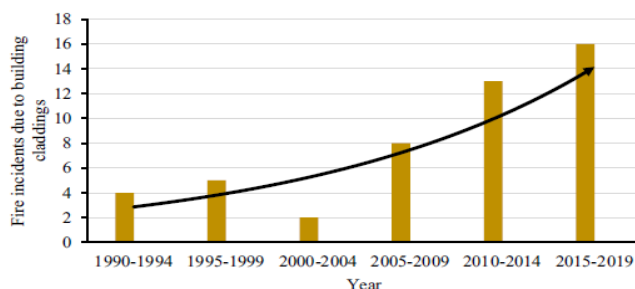

Figure 1: statistical data of fire incidents worldwide every five years from 1990–2019 [1].

National Fire Protection Association (NFPA) presented that most fire deaths are the result of smoke inhalation rather than burns.). Although the increased use of lightweight polymeric materials in cladding systems addressed environmental concerns such as meeting the targets for reduced carbon emissions [2].

In the last decade, several fire accidents occurred in high rise buildings and skyscrapers causing a great damage to the human life, properties, and the environments. Unlike small buildings, the fire starts somewhere inside the high-rise buildings or skyscrapers. The fire can initiate in any apartment in a typical residential floor, or at any typical car parking floors, surprisingly the fire spreads rapidly outside the building and catches the exterior façade with a vertical horrible flame. The fire breaks out were reported many times in difference places and cities of United Arab Emirates UAE, mostly in the big cities.

Recent dramatic events happened around the world (Mermoz Tower in Roubaix, France, 2012; Polat Tower in Istanbul, Turkey, 2012; Lacrosse Tower in Melbourne, Australia, 2014; Torch and Marina Tower in Dubai, United Arab Emirates, 2015; and Grenfell Tower in London, UK, 2017) remind of the importance of addressing fire issues as a whole and clearly highlight the major role played by façade cladding and the associated insulation as fire propagation vectors. [3].

Furthermore, many fire accidents were ignited in the last decade in high-rise buildings all around the world.

"TABLE 1" provide non-exhaustive list of the fires that have happened internationally because of combustible facade systems, and "Fig.2" showing and providing an illustrative map for the location of fires that engulfed all around the world [4].

From the schedule and map, it is clear that the Arab Gulf States gained the biggest number of the fires, This is what encouraged to search and focus on finding a solution to this phenomenon, which is spread in general around the world and in the UAE in particular, because of its distinction in building tall towers, the latest of which is Sheikh Khalifa Tower, number one in the world until today.

Country	City	Fire incidents involving the façade assembly on the exterior of a building							
		2017	2016	2016	2015	2012	2012	2008	2007
UAE	Dubai								
	Ajman		2016						
	Abu Dhabi		2016						
	Sharjah		2015	2012	2010				
Qatar	Doha		2010						
Russia	Grozny		2013						
Australia	Melbourne		2014						
	Fairfield		2002						
China	Shenyang		2016						
	Beijing		2011	2010	2009	2008			
Azerbaijan	Baku		2015						
Turkey	Istanbul		2012						
Thailand	Bangkok		2012						
Bangladesh	Dhaka		2016	2012					
USA	Atlantic City		2007						
	Reno		1997						
	Philadelphia		1991						
Hungary	Miskolc		2009						
France	Dijon		2010						
	Epinay-sur seine		2016						
	Lille		2016						
	Roubaix		2012						
Belgium	Neder-over-Heembeek		2016						
Germany	Berlin		2016						
	Munich		2005						
Spain	Ovideo		1996						
Canada	Winnipeg		2016						
S. Korea	Busa		1990						
UK	Liverpool		2010						
	Irvine		1991						
	Hereford		1999						
	London		2017	1993					
Japan	Hiroshima		1996						
Indonesia	Jakarta		2015						

Table1: List of Fire Incidents Involving Exterior Façade System Globally [4].

shown that flame spread through the air cavity of a ventilated façade can be several times higher than that along the outside the facade.

Furthermore, the presence of an air cavity tends to increase the energy released by the facade system. Thus, both the materials taken independently and the whole system (combination of materials and assembly) are potentially a source of propagation of a fire. At present times, the use of fire barriers or compartment systems, as requested by national regulations, can hinder these problems, but they too constitute additional variables in the system [3].

The fire behaviour of an external façade insulation system is dependent on the overall system's performance, rather than the performance of the individual components. A façade system includes not only the cladding and the insulant's characteristics but also those of cavities, cavity barriers, mounting and fixing, substrate, and any singularities, such as window frames. All these elements interact strongly when involved in a fire[12].

According to European Fire Classification of Materials since the beginning of 2007 in Finland, building materials must be tested for their reaction to fire. Testing based data can be used for classification according to SFS 13501-1. This publication includes requirements for building surface materials, such as ceiling to have a certain reaction to fire performance when in direct contact with fire.[13].

There are seven main categories of construction materials, depending on the reaction to fire of testing material, Table 2.

Table 2: European Fire Classification of The Building's Materials. (SFS EN 13501-1:2009, P.7) [13].

A1 A2	Non-combustible
B	Material of limited combustibility
C	Combusts in a period of 10-20 minutes
D	Combusts in a period of 2-10 minutes
E	Combust in a period of 2 minutes
F	Material provides no resistance to fire

The gap between the Aluminium Composite Panels (ACPs) and external wall, is a major factor of fire extension on the facade of high-rise building, it is playing very important role to prevent vertical fire flame spread, more than one problem was found in this position, the first being depth of the cavity, which varied from 90mm by British code up to 300mm by UAE code. This gap also considered as a levelling monitor to adjust the defects in the civil works in the external walls, "Fig.3" showing the proposed model of Aluminium Composite Panels ACPs.

In this paper, it was focused on Aluminium Composite Panels (ACPs) material as all other construction materials that must be tested and get certified before launching in the markets for consumers. A lot of certification authorities and labs around the world are involved in testation and issuance the certificates for tested construction materials.

In this simulation test it was concentrated on investigations and testation's the (ACPs) materials and model in general and depth of the gap particularly. ACPs is the main material that needs to be tested before installing at high-rise building and (Must be non-flammable) to avoid vertical fire flame and minimize the fire risk.

“Aluminium composite panels could melt in high temperatures, and flame and hot gases could enter the cavity between the panels and insulations. The use of fire stops between the outer panels and inner insulation materials was found to be effective to control the fire spread in the cavity”[14].

The gap depth is the subject matter of many works but, it is still needing more in-depth studies to find the optimal and safe depth that will be suitable enough to use in the recent high-rise buildings.

In accordance with what has been achieved by development and progress in the design of high-rise buildings in general and the external facades in terms of aesthetics first, and then their compliance with the conditions of sustainability such as energy saving, thermal insulation, etc., there are still many challenges that architects, and designers face in designing their high-rise projects. Represented in the danger of fires and the rapid spread of their flames in high-rise residential buildings.

It was found that one of the main factors for the spread of vertical flames in skyscrapers is the presence of gaps or cavities in most models used until today. Furthermore, and to importance and seriousness of this

phenomenon, the authors decided in this paper to focus on in-depth research using most contemporary scientific means to find the best solutions for it.

II.MODEL CONSTRUCTION

This simulation experiment test aims to examine, improve, and develop the exterior wall assemblies that cladded by ACP's material system, in compliance with applications and laboratory tests approved globally as BS8414 part 1 & 2, ISO 13785 part 1 & 2, NFPA 285, SP105, CAN/ULCS134, DIN 4102-20.

The proposed tested model"Fig.4" Constructed as the followings:

- 2.1 From the main metal skeleton size 5453mm length(height) and 4551mm width.
- 2.2 The fire opening at the bottom of the model size 75.7cm length (height) and 198cm width.
- 2.3 Proposed model layers as the following:
 - 2.3.1 200 mm block wall
 - 2.3.2 15x15x1mm aluminiumU channel [panel joint sealing].
 - 2.3.3 50 mm mineral wool insulation density 24 kg/ m³.
 - 2.3.4 cavity fire barrier size -depth=111xheight=57m x long variable recompresses stone wool density 80kg/m³.
 - 2.3.5 4mm aluminium composite panels.
 - 2.3.6 Fenomastic hygiene emulsion silk paint.
 - 2.3.7 1.5 mm thick galvanized steel [ASTM a653 / a653m] window flashing.

"TABLE 3" presents comparison between the proposed novel model and the traditional model (classical). The novel model contains all the materials and elements that were tested through conducting the simulation test for the experiment, and it is the one that succeeded in passing all stages of the experiment, which gave promising results in reducing the problem of the spread of fire from one floor to another and eliminating the problem of spreading vertical flame.

Table 3: The Table Shows the New Main Hypothesis Compared with The (Traditional) ACP Systems.

Serial No.	Design Parameters of ACPs	Traditional Model	Proposed Novel Model	Selected Model After Simulation Test
1.	ACPs itself combustible with polyurethane core	- Old traditional Model		
2.	ACPs noncombustible with mineral core	- Latest product of ACPs	1. ACPs noncombustible with mineral core A2	ACPs Mineral core A2
3.	Water proofing system	- Classic Bitumen Paint	1. Fire rated bitumen paint. 2. Fenomastic hygiene emulsion silk paint.	Fenomastic hygiene emulsion silk paint.
4.	Heat insulation system	1. Rock wool 2. Polystyrene foam	1. Rock wool 2. Mineral wool.	Mineral wool.
5.	Gap between wall and ACPs.	Size of the gap allowed up to 250mm.	1. Predictable thickness of the cavity (Required simulation test)	Optimal gap (cavity) thickness is 111mm
6.	Joints between Panels.	1. Not closed properly 2. Mastic used is Flammable	- should be closed and fixed properly - nonflammable mastic to be used	prolastikmatt silicone sealant
7.	(Cavity barriers) Existing horizontal fire rated stoppers (compressed stone wool size 120 *57mm)	One or two barriers used	Strictly recommended to use more barriers (Predictable number of barriers) (Required simulation test)	Optimal number of barriers used is 4 (Compressed stone wool size 120 *111mm)

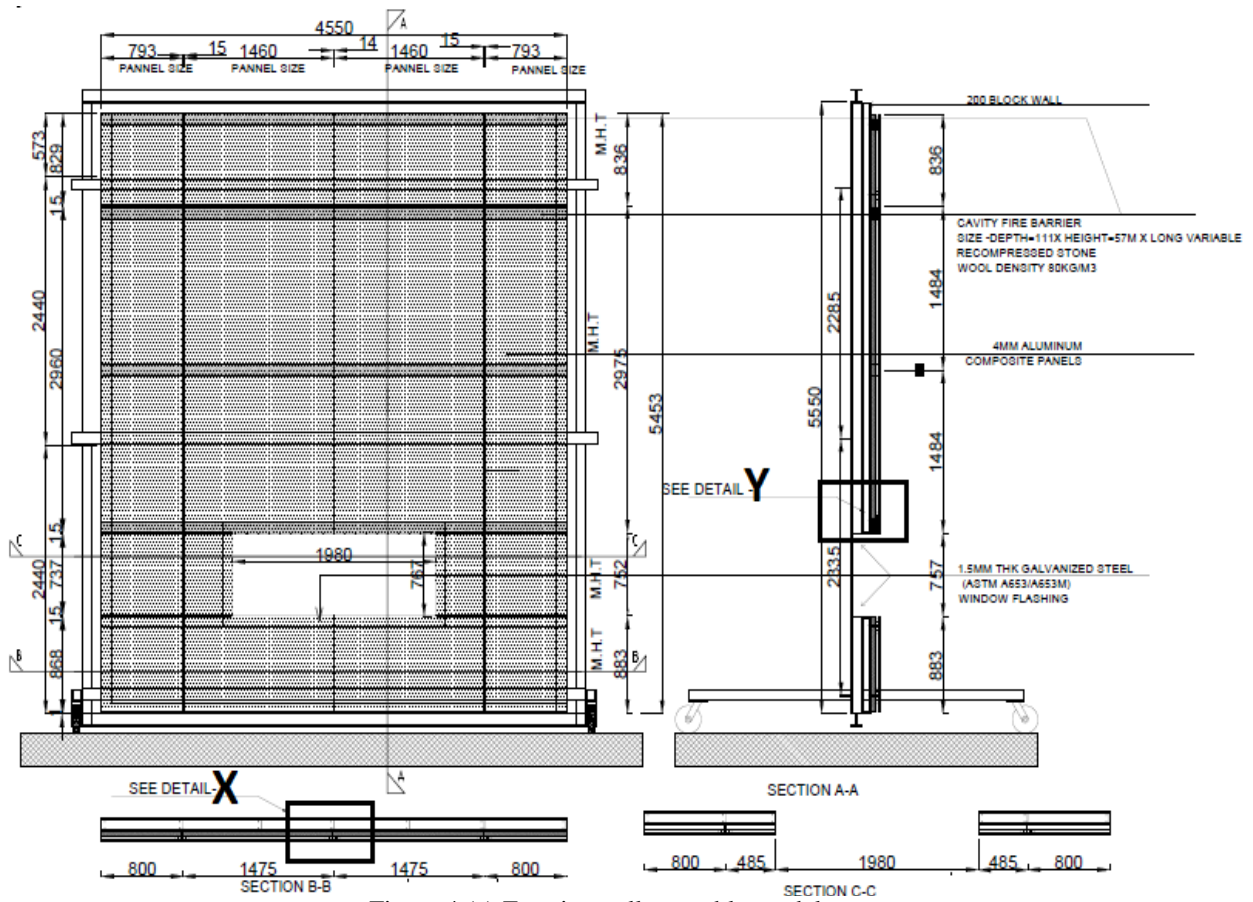

Figure 4 (a):Exterior wall assembly model.

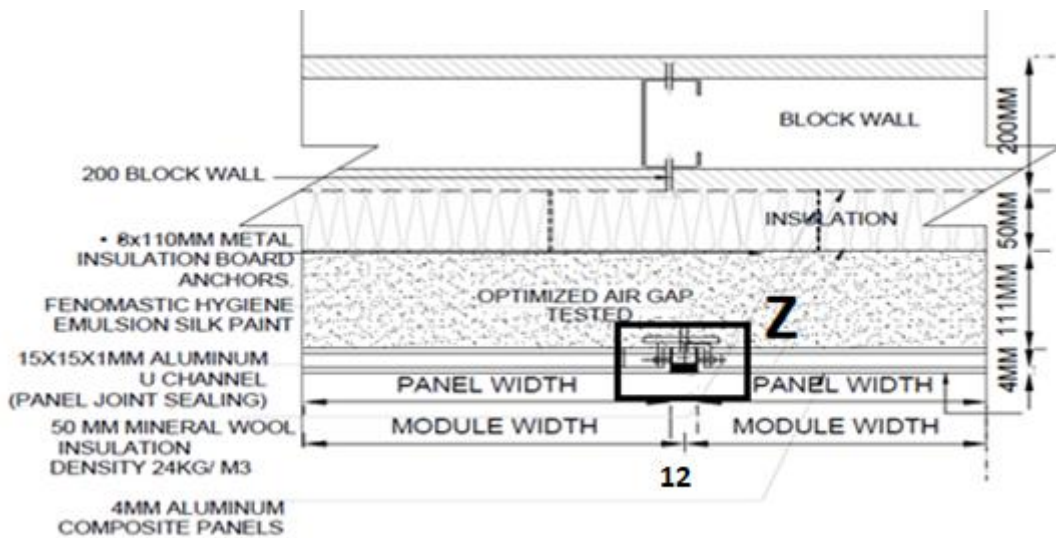

Figure 4 (b):Details of section X - X.

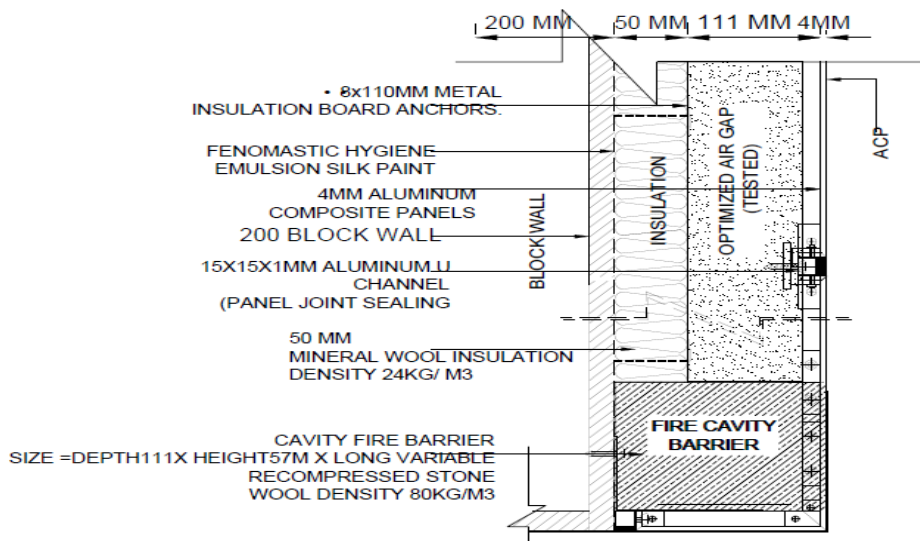

Figure 4 (c):Details of section Y - Y.

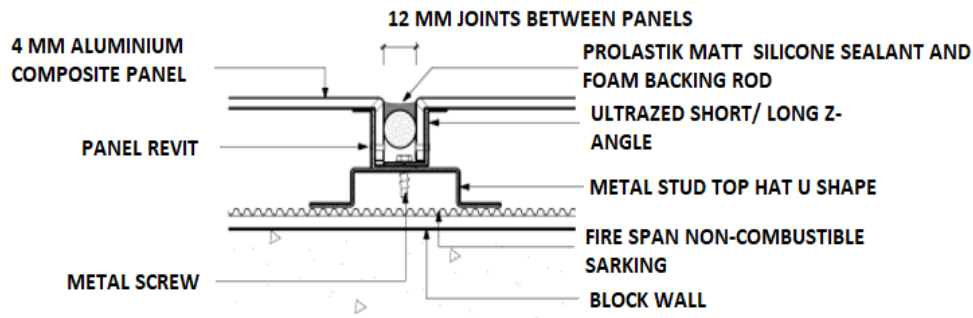

Figure 4 (d):Details of section Z - Z.

Figure 4:Details of the proposed tested model of ACPs.

2.4 Installation way of ACPs and joints between Panels.

Aluminium Composite panels (ACPs) are typically installed to exterior walls on steel channels or battens/top hats, [20]. This creates an air gap around 40 mm between the next surface within the external wall cavity (typically sarking or other weather resistive barrier) and the cladding. The panels are typically fastened to the steel battens by either of the following two methods:

2.4.1 Flat stick method - flat cut ACP panels adhered to steel battens using double sided adhesive tape.

2.4.2 Cassette mount method - the edges of the panels are folded at right angles and are rivet or screw fixed to aluminium or steel channels or clips which are in turn screw fastened to the exterior wall.

Sealant is normally applied to the gaps between panels, this is called "face sealing". The Cassette mount method of installation typically forms a ventilated façade/rain screen with an air gap separating the ACP from the supporting wall behind. However, ACP can be incorporated into other forms of construction including pre-manufactured unitised curtain wall façade panels, etc". detail Z "Fig.4(d)"above showing the best installation way of ACPs and joints between Panels.

Figure 5(a)shows three-dimensional images of the model, including the method of installing and fixing the composite aluminium sheets on metal supports fixed to the block wall, in addition to installing fire barriers and thermal insulation in their specified places[21].

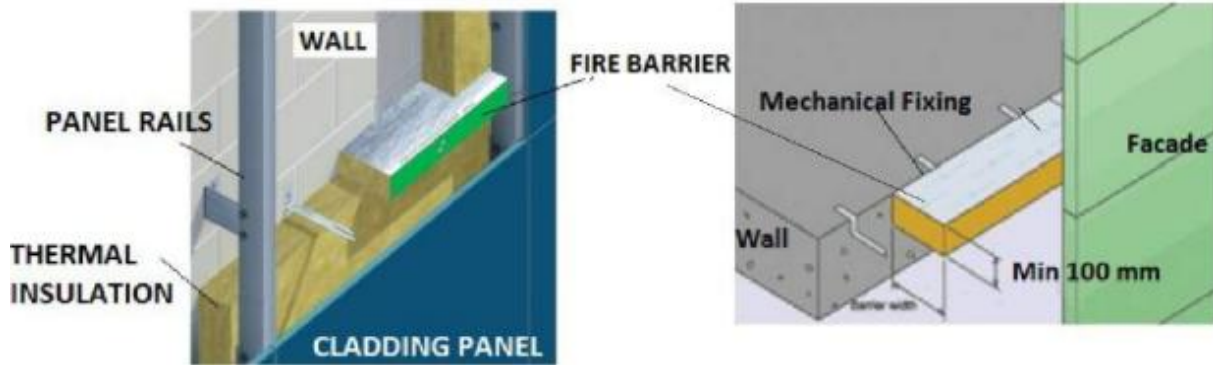

Figure 5 (a): three-dimensional images of the model [21].

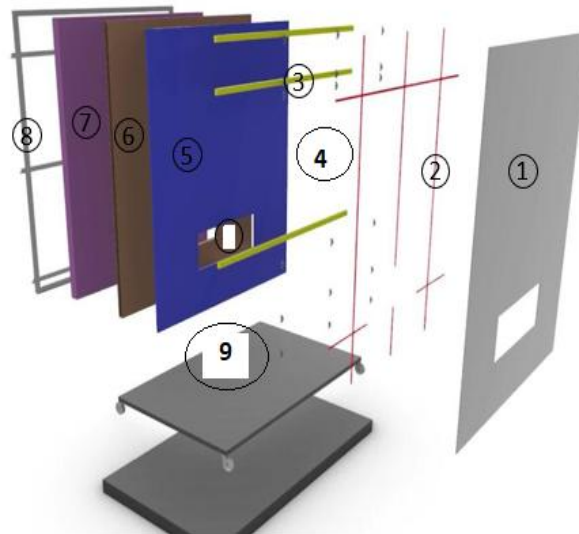

Figure 5 (b):Layers and specifications of the novel model.

Figure 5 (b) shows the fully layers (components of the novel model) which are complementary for figure 5 (a):

1- 4MM THK aluminum composite panel FR-A2.

2- Vertical/horizontal runners: 40X40X3MM

alum hollow square tube.

fixed to the panel rails brackets.

3- Cavity fire barrier size= depth111 mm*height 57 mm*long variable recompressed stone wool density 80 kg/m³

4- Gap(Air Cavity) 111mm.

5- Thermal insulation 50 MM mineral wool insulation density 24KG/ M³.

6- Fenomastic hygiene emulsion silk paint.

7- 200 MM block wall fixed to the metal frame.

8- Steel frame supporting block wall.

9.Model base.

III.METHODOLOGY AND RESULTS

In this paper the conducted simulation test was focused accurately to find the optimal depth using the Evolutionary Algorithm theory in cooperation with the CALI-S. T professionals and designers, (Jordan, USA).

3.1. Evolutionary Algorithm Implementation

The main objective of work is the limitation of fire spread within insulated façade of high-rise buildings. Observations and experience show that façades have a large potential to contribute to the spread of fire between floors and apartments of residential buildings. Many reports on fire accidents prove that the presence of a cavity (gap) assist spreading of vertical flames in high-rise buildings. Therefore, studying and analysing the 'façade in fire' - scenario helps to develop safety methods and potential mitigating strategies, [15].

To achieve a fully automated design, variants creation and considering parametric modular coordination, Rhino and Grasshopper software packages were used as an integrated computer design tool with an algorithmic method. Parametric modelling tools can simplify a wide range of possible concepts for optimal design exploration by allowing the automatic generation of a group of alternative design solutions to achieve the optimal genome model [16].

The optimal design of an Aluminium composite panels (ACPs) that can minimize the vertical fire flame and fire risk in high-rise buildings while maximizing the safety and durability is a challenging and expensive to perform due to complexities and constraints encountered.

Computational costs of such constraints manifest itself in many indices of complexity, namely the availability of many combustible materials in commercial wall assemblies. These assemblies include exterior insulation, metal composite claddings, high-pressure laminates, and weather resistive barriers. Likewise, modelling complexity deals with the methods used to find a solution to the problem in hand. Simple models admit closed form solutions while the more complex require robust optimization or finite element models. Furthermore, thermal loads of ACPs are highly sensitive to geometric tolerances and imperfections. One of the most significant parameters is the air cavity (gap) between the external wall of the high-rise buildings and the ACPs used for cladding. While there is still no good way to incorporate imperfections in the design because their amplitudes and shapes are not known, designers often concentrate only on the cavity (gap), the most critical scenarios for the design optimization.

In compliance with this last requirement, the optimum cavity (gap), an evolutionary algorithm (EA) in accompany of parametric design were adopted within the integrated platform of Rhino 3D, Grasshopper and Galapagos software, "Fig.6 and Fig.7" [22].

This process is supported with Galapagos which uses genetic fitness to eliminate unwanted characteristics (here larger cavity (gap) size) and to select genes (here member sizes and properties) that evolved towards genetic success (here minimum cavity (gap) size). A unique feature of this optimization is the efficient reduction of variables that were genetically modified [17]. The application of the evolutionary algorithms to structural optimization allows a huge reduction of the time and computational effort. In general, EAs search a multi-dimensional space for points according to predefined fitness function, then using some selection mechanism to discard unfavourable points, making better the working set [18].

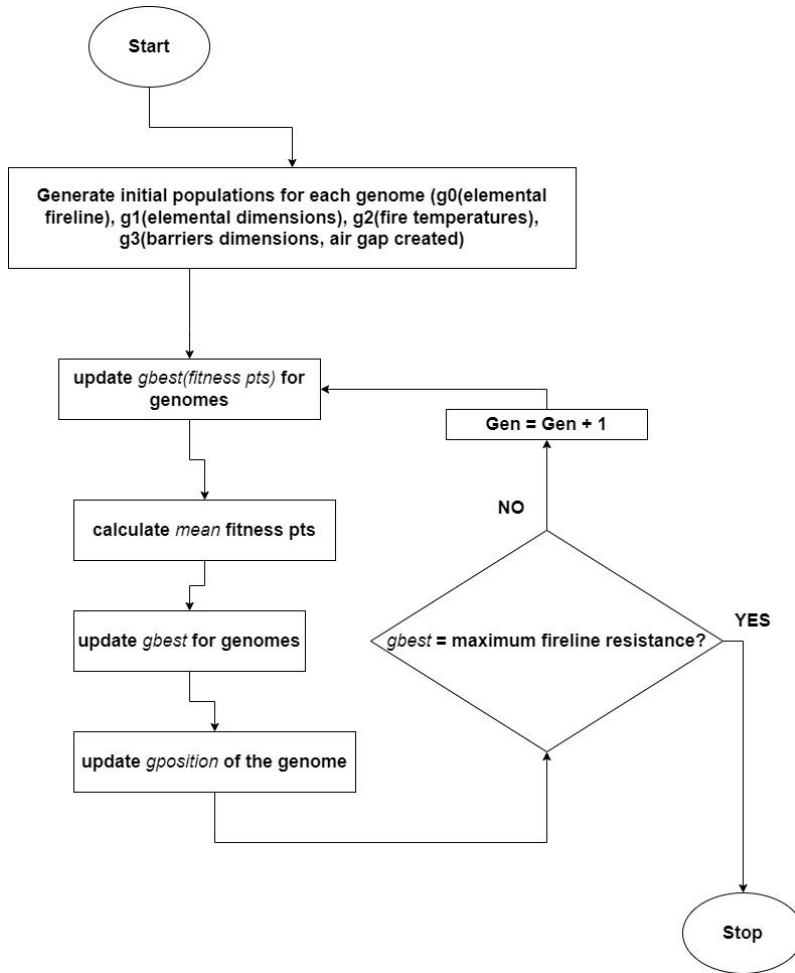

Figure6:Flowchart of the proposed algorithm.

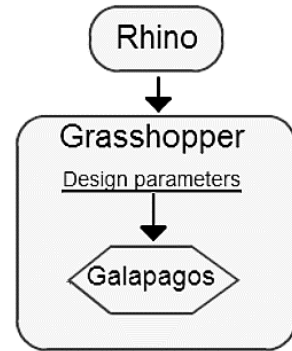

Figure 7:Software interaction. It shows relationship among various software's utilized in this work. Within this virtual environment engineers and architects can optimize structural form for a given set of criteria. Furthermore, galapagos provides a general platform for applying evolutionary algorithm for use in variety of solutions problems by non-programmers [19].

The Grasshopper software starts with standard input as shown in "Fig.8"(exploded par). The design parameters shown are defined to Galapagos via C-Sharp (a programming language). This will be explained thoroughly in the following.

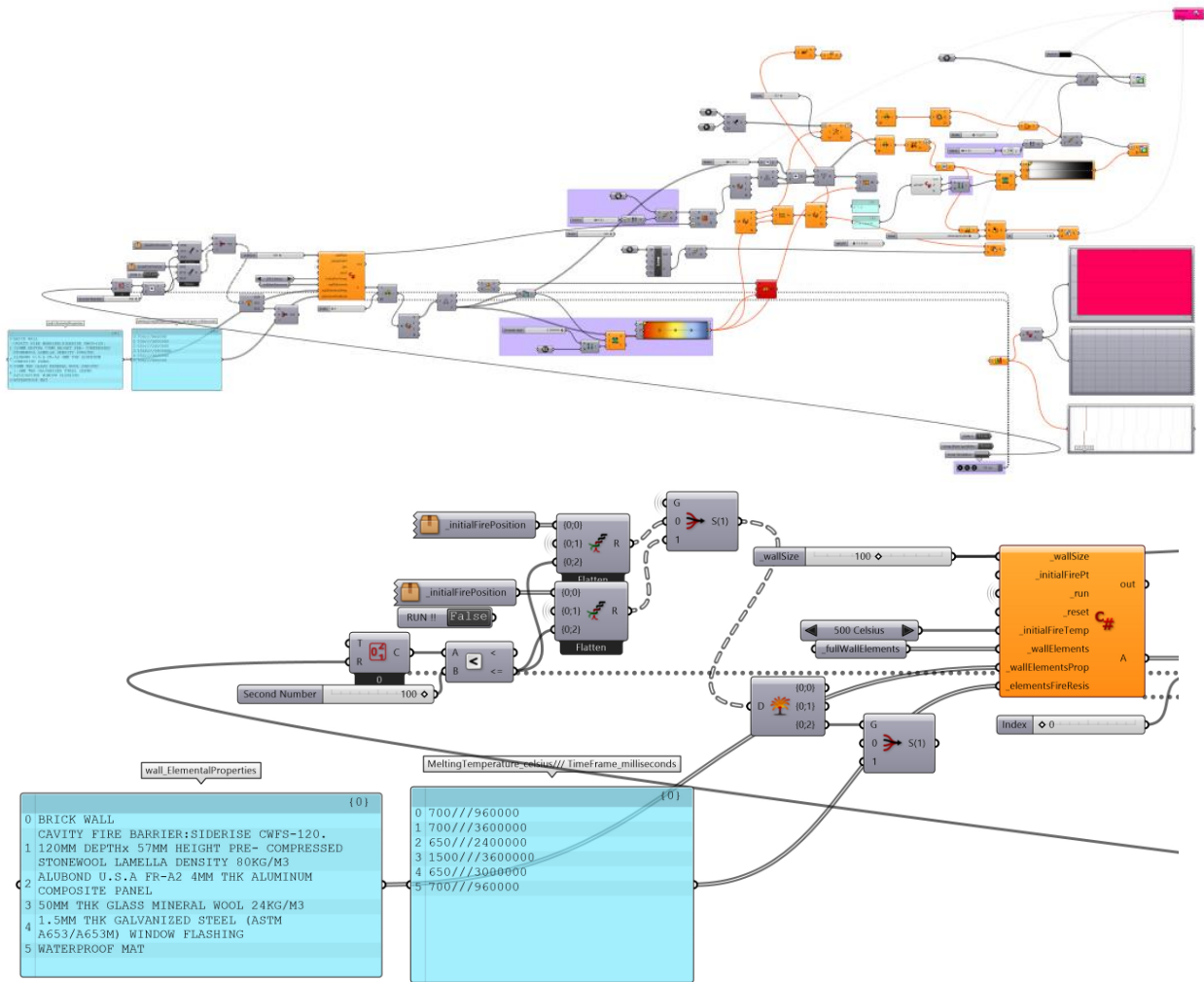

Figure 8: Parametric relationships chart within the grasshopper program (part of the figure is exploded to make the picture clear).

Galapagos, the solver, starts with a random “population” of sets of input values. These sets of input values are plugged into the model (using C-sharp) and the results are evaluated relative to the target value, i.e., the optimum gap (OG):

$$OG = \left\{ \begin{matrix} x_0(\text{function})[\text{target}], x_1(\text{function})[\text{target}], x_2(\text{function})[\text{target}], \\ \dots x_n(\text{function})[\text{target}] \end{matrix} \right\}, \quad (1)$$

where x is the parameter (input value) and n is the number of parameters used.

In this work, all the parameters are dealt with as dynamic ones to simulate the heat flux, materials resistance, and the compound structure layers of the testing facade.

The input parameters are:

x_0 : is the initial fire temperature (Temp). It will take the values from 200 - 500 °C.

x_1 : are the façade materials (labels) elements (FE); ACP (Aluminium Composite Panels), HI (Heat Insulation), WP (Water Proofing), Gap, CB (Cavity Barriers), and BW (Brick Wall).

x_2 : are the façade element properties (FP) (height*width*depth); ACP (5,4,0.004), HI (5,4,0.05), WP (5,4,0.001), Gap (5,4,0.005), CB (4,0.1, 0.005), and BW (5,4,0.02). Note that the dimensions are in meters.

x_3 : is the elements fire resistance (FR) (°C/min); ACP (650,40), HI (1500,60), WP (700,16), Gap (), CB (700,60), and BW (700,16). For example, the ACP takes 40 mints to melt at 650 °C.

x_4 : is the time (t) (CPU dt = 10 ms) * (target dt = 2.7×10^6 ms). (45 min is the experiment duration). (ms is millisecond).

It is worth mention that in Eq. (1) the field which refer to function is kept empty in Eq. (2) since there is no functions for all elements.

$$OG = \left\{ \begin{array}{l} Temp () [200 - 500], FE () [ACP, HI, WP, Gap, CB, BW], \\ FP () [ACP(5,4, 0.004), HI(5, 4, 0.05), WP(5,4, 0.001), Gap(5,4, 0.005), CB(), BW(5,4, 0.2)] \\ FR () [ACP(650,40), HI(1500, 60), WP(700,16), Gap(), CB(700,60), BW(700,16)], t () [2.7 \times 10^6] \end{array} \right\} \quad (2)$$

Finding the optimum gap is computationally demanding and a large number of iterations were performed. In this text, two sample iterations in the vicinity of the optimum gap are presented. In the first sample, the air gap is assumed to be 70 mm, then EA runs for the whole input parameters for 45min (the time of experiment recommended by NFPA 285). The data recorded on the external layer and resistance pressure show that the results are not promising, and the facade will collapse after 17min because the air pressure between the barriers and compounding structure of the facade will lead to internal explosive pressure.

In the second sample, the air gap is assumed to be 150 mm, then again, the EA runs for the whole input parameters for 45min. The data recorded on the external layer and resistance pressure show that fire extrapolation growth vertically will increase by 12.1% which will lead to external explosive pressure in the upper levels after 26 min, because of the oxygen volatility between the barriers.

As the result of EA, the optimum value for the air gap is 111mm which holds the most precise values for the equation to reach the targeted fitness point with ~40.27 min.

IV.DISCUSSION

As the result, our output for the air gap from Evolutionary Algorithms(EA) is = 11.1cm which holds the most precise values for the equation to reach the targeted fitness point with delta time dt = 2416 sec (~40.27 min), that will lead to the great benefits and starting economical products in the industrial construction field for validation of the novel model of ACPs.

The results always variable and depend to the specification or layers of the ACPs that including non-combustible ACPs, non-flammable heat insulation and waterproofing insulation and perfect way of ACPs installation.

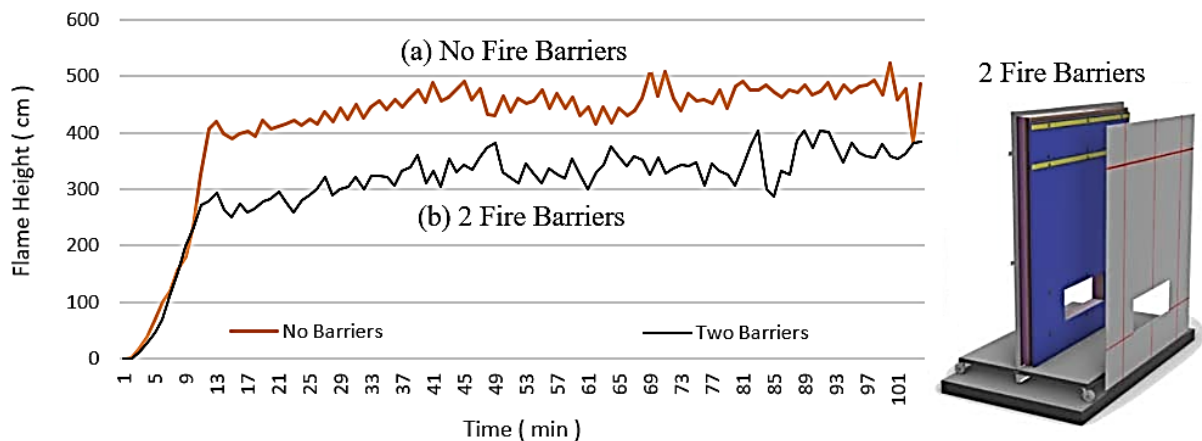

Figure 9:Flame height versus time(a) no fire barriers used(b) two fire barriers used.

The experience of this simulation test confirms (that the use of a larger number of fenders or fire barriers between the outer wall and the ACP cladding) resists the spread of fire on the facades of buildings in general and the speed of vertical flames rising particularly. These fenders play a positive and effective role in preventing the transmission .

of fire from one floor to another and prevent its spread vertically. Which affects the lives of the residents, the property, and the buildings themselves.

Figure 9 shows the results extracted from the performed simulation test for proposed novel model. It is clear that there is a considerable difference between the height of fire flame when no fire barriers used, and when two fire barriers used. It is clear that when using more fire barriers, the vertical fire flame height will be decreased. These results strengthen the validity of the numerical simulation performed in this work, and it gives a proof that continuous improving such numerical techniques will give valuable and promising results.

V. CONCLUSIONS

Overall, based on the results have been gained about the simulation test, by using evolutionary algorithm assessment as discussed, an important consideration which supporting and enhancing the generated genomes that improving the efficiency, choosing the best solutions, and focusing on best generated genomes that will improve the novel model of ACPs to minimize the risk of vertical fire flame in high-rise building.

Although the obtained results are promising and made a qualitative leap in the world of the construction industry, the subject needs more research and scrutiny to obtain an ideal model that contains all safety elements for the towers, their occupants, and the surrounding environment.

Acknowledgements

I am gratefully acknowledged Prof. Dr Awad Saad and Prof. Dr Osama Abuzeid who have supported me to fulfil this work and gave me continued cooperation and golden opportunity to do this wonderful project. Finally, I extremely thankful to M/S CALI-S. T professionals and designers for providing me necessary technical suggestions during my research pursuit.

REFERENCES

- [1]. Bonner M. & Rein G. (2020) List of Facade Fires (1990 – 2020).
- [2]. Hossain, M. D., Hassan, M. K., Yuen, A. C. Y., He, Y., Saha, S., & Hittini, W. (2021). Flame behaviour, fire hazard and fire testing approach for lightweight composite claddings—a review. *Journal of structural fire engineering*, 12(3), 257-292
- [3]. Dréan, V., Girardin, B., Guillaume, E., & Fateh, T. (2019). Numerical simulation of the fire behaviour of facade equipped with aluminium composite material-based claddings-Model validation at large scale. *Fire and Materials*, 43(8), 981-1002.
- [4]. Lamont, S., & Ingolfsson, S. (2018). High Rise Buildings with Combustible Exterior Wall Assemblies: Fire Risk Assessment Too National Fire Protection Association Report.
- [5]. Duny, M., Dhima, D., Garo, J. P., & Wang, H. Y. (2019). Numerical and theoretical evaluations of a full-scale compartment fire with an externally venting flame. *Fire Technology*, 55, 2087-2113.
- [6]. Sharma, A.; Mishra, K.B. Experimental investigations on the influence of ‘chimney-effect’ on fire response of rainscreen facades in high-rise buildings. *J. Build. Eng.* 2021, 44, 103257.
- [7]. Agarwal, G. Research Technical Report: Evaluation of the Fire Performance of Aluminum Composite Material (ACM) Assemblies Using ANSI/FM 4880; FM Global: Norwood, MA, USA, 2017.
- [8]. Chen, T.; Yuen, A.; Yeoh, G.; Yang, W.; Chan, Q. Fire risk assessment of combustible exterior cladding using a collective numerical database. *Fire* 2019, 2, 11.
- [9]. Kamrul H. Md*, Delwar H. Md, Gilvonio M., Payam Rahnamayezekavat, Grahame Douglas, Sameera Pathirana and Swapan Saha September (2022) Numerical Investigations on the Influencing Factors of Rapid Fire Spread of Flammable Cladding in a High-Rise Building
- [10]. Petresevics, F., & Nagy, B. (2022). FEM-Based Evaluation of the Point Thermal Transmittance of Various Types of Ventilated Façade Cladding Fastening Systems. *Buildings*, 12(8), 1153.
- [11]. Cooke, G. M. (2001). Sandwich Panels for External Cladding: Fire safety issues and implications for the risk assessment process. *Fire Engineers Journal*, 60, 31-36.
- [12]. Sean T. McKenna, Nicola Jones, Gabrielle Peck, Kathryn Dickens, Weronika Pawelec, Stefano Oradei, Stephen Harris, Anna A. Stec, T. Richard Hull, Fire behaviour of modern façade materials – Understanding the Grenfell Tower fire, *Journal of Hazardous Materials*, Volume 368, 2019, Pages 115-123, ISSN 0304-3894,
- [13]. Bytskov, G. (2015). Numerical simulation of fire performance and test conditions for facade insulation materials (Master's thesis).
- [14]. Peng, L., Ni, Z., & Huang, X. (2013). Review on the fire safety of exterior wall claddings in high-rise buildings in China. *Procedia Engineering*, 62, 663-670.
- [15]. White, N., & Delichatsios, M. (2015). Fire hazards of exterior wall assemblies containing combustible components. Springer.
- [16]. Trissi, S. M. S., Kayali, M. N., & Darwish, A. H. (2021). Sustainable Architectural Design of the Residential Compound Towers in Aleppo City Using the Genetic Algorithm. *مجلة العلوم الهندسية وتكنولوجيا المعلومات*, 5(5), 126-147.
- [17]. Gerbo, E. J., & Saliklis, E. P. 2014. Optimizing a Trussed Frame Subjected to Wind Using Rhino, Grasshopper, Karamba and Galapagos. In Proceedings of IASS Annual Symposia (Vol. 2014, No. 13, pp. 1-7). International Association for Shell and Spatial Structures (IASS).
- [18]. Kruchten, N. J. 2003. Galapagos: a Distributed Parallel Evolutionary Algorithm Development Platform, BSc dissertation, University of Toronto. <https://doi.org/10.1016/j.jhazmat.2018.12.077>. (<https://www.sciencedirect.com/science/article/pii/S0304389418312275>).
- [19]. Rutten, D (2010). “Evolutionary Principles applied to Problem Solving, <https://www.grasshopper3d.com/profiles/blogs/evolutionary-principles>”
- [20]. Hite N. May 2020 Fire performance and test methods for ACP external wall cladding.
- [21]. <https://www.bluechipgroup.net.au/facade-cladding-perth/aluminium-composite-panel-perth.html>.
- [22]. <https://www.rhino3d.com/>.