

# Energy-Efficient Passive Optical Network (PON) Planning with Wavelength Allocation Scheme based on User Behaviors and Bit Error Rate (BER) Performance Evaluation

Satyaki Kumar Biswas<sup>1</sup>, Amitava Podder<sup>2</sup>

<sup>1</sup>(Department of Electronics and Telecommunication Engineering, JIS School of Polytechnic, Kalyani, India)

<sup>2</sup>(Department of Computer Science and Technology, JIS School of Polytechnic, Kalyani, India)

---

**ABSTRACT:** PON is very useful technology which are used as broadband access network. This system shares one optical fiber cable among multiple subscribers by using power splitter connected with different Optical Network Unit (ONU) located to subscriber's premises. One of the main objectives of PON network planning is to make it energy-efficient with good performance of BER. So here a network planning mechanism is proposed which is based on study of user behaviours for bandwidth-demand requirement of subscriber and further depends on the BER performance of the allocated line. In this wavelength allocation (WA) schemes first we consider the different network utilization requirement from behaviours of different kind of users (i.e., daily bandwidth demand profiles), and then we can allots users (e.g., business and residential users) efficiently to different wavelengths. Further by evaluating the BER performance of all ONUs, the BER performance are improved for which communication through network achieve high network utilization at all times. The user behaviour-aware wavelength assignment and evaluation of BER Performance based system are capable to achieve improvement over traditional method in terms of used wavelengths and finally saves the energy consumed by the Network.

**KEYWORDS** - BER, Network Planning, Passive Splitter Combiner (PSC), User behavior, Wavelength Allocation (WA)

---

Date of Submission: 25-01-2021

Date of Acceptance: 10-02-2021

---

## I. INTRODUCTION

The broadband access network, which are also known as the "last mile access network", used to connect the network service provider central offices (COs) with the subscribers of business and residential category. Passive optical networks (PON) may be deployed as access network to communicate between Central office (CO) and Optical Network Unit (ONU). Due to the explosive increase in bandwidth demand of the market, the main objective of the broadband service provider or any researcher are on the subject that how to exploit the vast data communication capacity of optical fiber. PON is an important solution for the broadband access networks having the potential for data capacity up to 100 Mbps or more. Further, a truth about PON broadband access networks is that, it is the best method to reduce its operational cost (Op-Ex) by lowering the total number of active sites such as points of presence (PoPs) and local exchanges (LXs) [1] and by eliminating the power supply along the fiber path from CO to customer premises, which contributes a large part of the Op-Ex. Another important focus point of PON system is to maintain good signal-to-noise ratio (SNR) figure through the communication line connecting CO to ONU for both upstream and downstream direction.

So to achieve high signal-to-noise ratio (SNR) through PON, it is important to maintain low bit-error rate (BER) with high transmission speed and high split ratio of signal which causes to attenuate the signal by a great amount. Apart from the innovative efforts on the physical layer, most of the PON stick with the "tree-and-branch" topology inherited from traditional PON architectures, but have a much longer feeder section from the CO to the Local Exchange. Here Fig. 1 shows the architecture of a typical PON with "tree-and-branch" topology. Instead of the traditional "tree-and-branch" topology, researchers are also investigating a "ring-and-spur" topology for PON system as shown in Fig. 2, where each PON segment with traditional FTTX tree topology and the OLT are connected through a fiber ring and remote nodes (RNs) deployed on the ring. An advantage of this design is that it can reuse the metro ring networks with fiber already deployed by substituting the RN equipments and thus achieve great savings on Cap-Ex. The ring topology has the capability to provide the PON, two-dimensional coverage for failure protection, which is also an important factor. Our proposal is applicable for both the case.

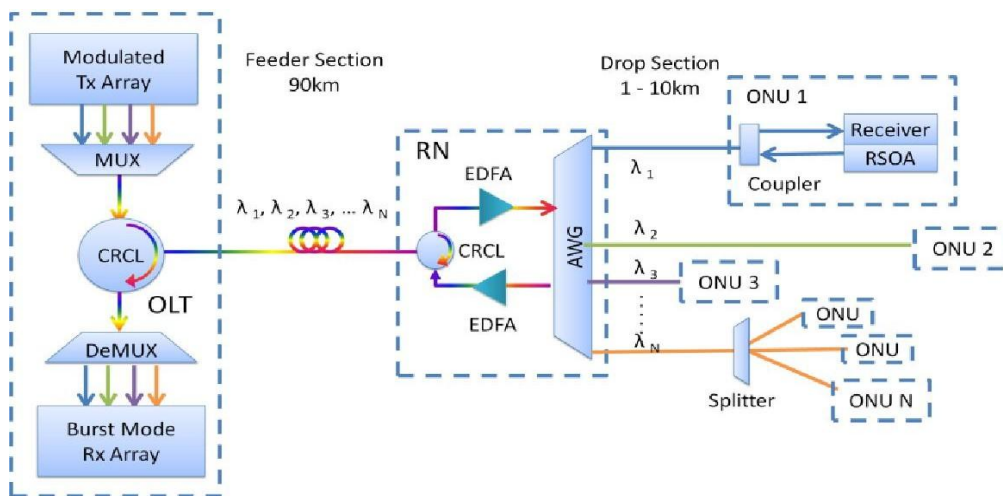

Figure 1. “tree-and-branch” PON realization deployed at both the feeder section and OLT.

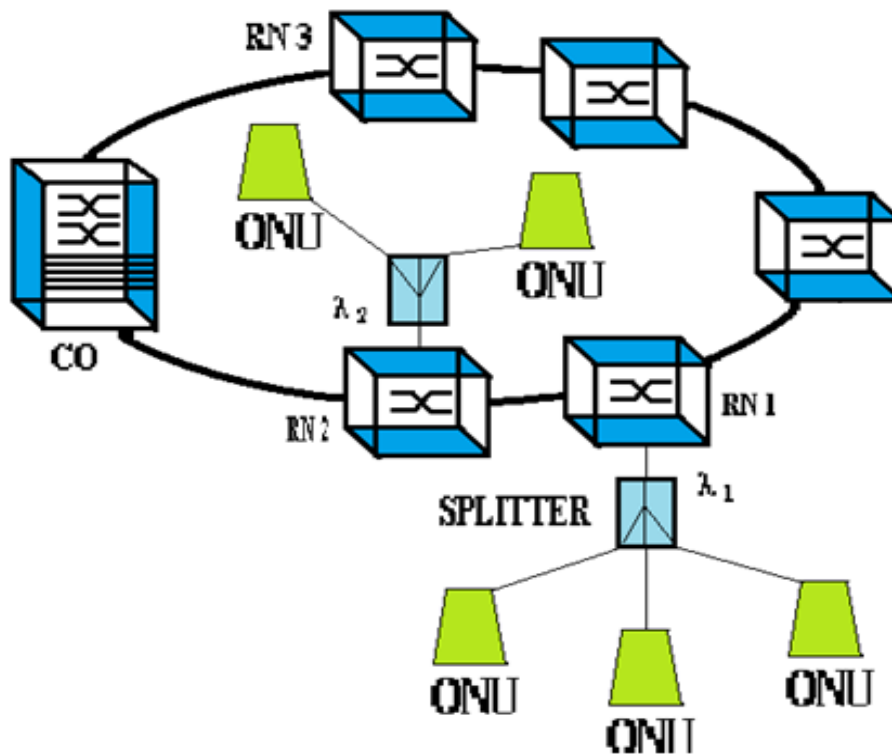

Figure 2. Demonstration of a “ring-and-spur” PON.

While research on PON system has so far mainly focused on designing PONs with optimized bandwidth efficiency by using sophisticated dynamic bandwidth allocation (DBA) scheme and exploiting the vast fiber capacity by using WDM technology, the “green” trend has been embraced by backbone networks where a typical strategy is to design network protocols that can save energy by putting idle network interfaces and other routing and switching components to sleep [2]. As access networks take up 70% of overall Internet energy consumption [3], which in turn consumes about 1% of total electricity consumption in broad band-enabled countries [4], we should consider energy efficiency in designing the PON. Here, we propose an energy-saving network planning approach based over user behaviors or time to time user’s bandwidth demand which are followed by BER performance evaluation of the communicating line of the network. First by carefully examining different users’ bandwidth needs and exploiting the complementary daily traffic profiles of business and residential customers, further by evaluating the BER performance of the communication line, we can design the PON with least number of wavelengths used for the system and keeps the network running at high utilization rate all the time.

By using fewer wavelengths we not only save both Op-Ex and Cap-Ex, but also save a lot on energy needed to run the network and thus improve the energy efficiency of PON.

PON system contains three parts, optical line terminal (OLT), ONU, and remote node (RN). ONU resides at RN, and generally OLT resides at the local exchange or Central Office (CO). Wavelength-Division Multiplexing (WDM) is applied to exploit vast bandwidth capacity of fibers, the Arrayed-Waveguide Grating (AWG) is deployed in the RN, serving as a passive wavelength router. Power splitters could be employed after the AWG in RN, or it is possible to be inserted in the drop section to increase the capacity with enabling the statistical sharing of bandwidth in single wavelength among multiple ONUs. For the PON system in general, the loss of power and inter-channel crosstalk characteristics of AWG at different channels (synonymous with wavelengths, with each channel/wavelength emerging from a unique AWG output port) experience different amount of signal attenuations, leading to different bit-error rate (BER) at the receiver end.

The BER performance of central channel performs better than the BER performance of side channels. On the other side, the difference of distance in the drop section varies significantly from ONU to ONU which also causes difference in received powers and to the BER too. A far-away located ONU may have worse BER figure than an ONU closer to the RN. An ONU-distance-aware (ODA) scheme becomes effective to be applied to achieve the lowest average BER. In our scheme, first we sort the ONUs according to their distance to RN, and then allocate wavelengths in the order of decreasing distance. Allocation of the best wavelength to the ONU need to be considered; so an ONU could not be allocated a worse wavelength than that ONUs nearer to the RN. The ODA scheme is also capable to balance the BER among ONUs and reduce the variance as it compensates the far-away ONUs with better wavelength channels. By verification of the BER performance of proposed path, the path will be finalized. If BER performance is good, it is convenient to finalize the rout otherwise the path is rejected and new path need to be found.

## **II. WAVELENGTH ASSIGNMENT BASED ON USER BEHAVIOUR**

### **2.1 Problem Statement**

A typical PON system has N segments; each of the segments is assigned with one separate wavelength that provides bandwidth to other of ONUs connected with this segment. Now consider a basic example of two clients, each having an ONU where the first one is a business client who requires high data transfer capacity during daytime and little around evening time, as demonstrated in Fig. 3(a). The subsequent one is a private client who needs huge data transfer capacity at night when he is at home however small requirement during daytime, as demonstrated in Fig. 3(b). If we have two choices to place these two clients in our PON system, we can either place them in two separate network fragments, which, from the perspective of OLT, will cause the OLT to employ data transmission as per the two clients' demand and due to that reason the network finally utilize more wavelength than really required. The second way to approach the problem is intentionally place them in one network portion, as demonstrated in Fig. 3(c). The advantage of this second option inhibited in the fact that the peak demand hours of the two users are different and thus the service provider only needs to allocate bandwidth according to their total peak bandwidth needs, which in this example, are almost the same as for one user. Further with observation of the different network usage behaviors of typical business and residential user client, it is possible to develop an efficient user group assignment scheme in which users with complementary behaviors are assigned to the same network part to share the bandwidth by which high bandwidth utilization may be achieved during most time of the day, as shown in Fig. 3(c), which further reduces number of wavelengths needed (along with cost and energy). The scheme is possible to be easily implemented in both the upstream and downstream direction since the two directions are identical for our problem under the setting of most of today's PON designs where the OLT provide separate but symmetric downstream and upstream bandwidth to each ONU using different wavelengths

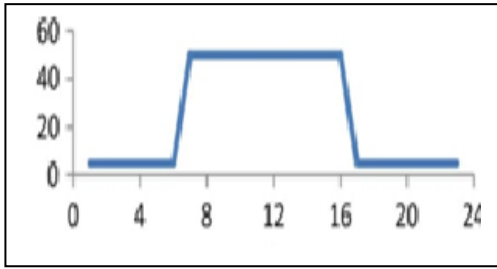

Figure 3 (a)

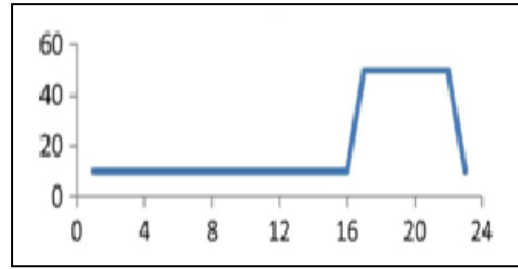

Figure 3 (b)

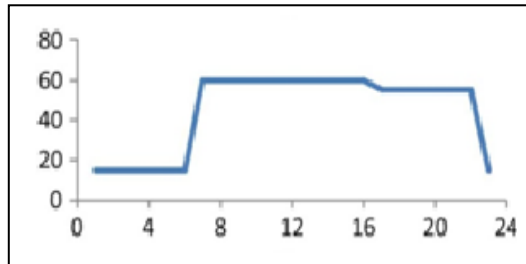

Figure 3 (c)

### 2.2 Mathematical Model

In this section, we will discuss about the mathematical model provided for the user assignment scheme in a “tree-and-branch” PON system. Kindly note that here we refer to the notations of symbols given in Table I.

**Table I**  
Symbols for the behavior-aware user assignment scheme

Symbol	Meaning	Typical value
$N$	Number of ONU, this is equal to the number of user having ONU	150
$M$	Number of PON segment, this number are equal to the number of wavelength used in the network section	06 to 08
$B_i$	The daily bandwidth demand profile of the user $i$ at particular time duration $[k]$	0 to 100 MBPS
$K$	Denote the user's daily bandwidth demand profile. One day is divided in equal length duration of 24 hours, so $K = 24$	24
$S$	Collective set of user's daily bandwidth demand profile	N/A
$C$	Total bandwidth provided by one wavelength	Up to 5 Gbps
$A_{ij}$	Binary value that shows whether user $i$ assigned with wavelength $j$ (or identically to network segment $j$ ) or not	0,1
$A$	User assignment array	N/A

To formulate the problem, a user’s daily bandwidth demand profile is considered as  $B_i$ , which is also used to describe the bandwidth need of users ’  $i$  ’ at different times of a day. Basically,  $B_i$  has  $K$  dimensions. Each value of  $K$  indicates the user’s bandwidth requirement at particular time duration  $[k]$  of a day. This profile could be obtained through mutual agreements between the user and the service provider. As different users may sign contracts using different profiles, the service provider eventually is given with a set ‘ $S$ ’ of different user profiles of all users (Let total number of users are ‘ $N$ ’), and the aim is to assign minimum number of wavelengths ( $M$ ) to accommodate all the required bandwidth without exceeding the bandwidth limit ( $C$ ) of each wavelength. We have to solve the issue mathematically and so, mathematically, we may proceed to formulate the problem as follows

Objective: Minimize  $M$  and find user assignment array  $A$  where:

$$A = \{ A_{11}, A_{12}, \dots, A_{1M}, A_{21}, A_{22}, \dots, A_{NM} \}, A_{ij} \in \{ 0, 1 \} \quad (1)$$

Given that,

$$B_i = \{ B_{i1}, B_{i2}, \dots, B_{ik} \}, \quad (2)$$

$$S = \{ B_1, B_2, \dots, B_N \}, \quad (3)$$

$$\sum_{j=1}^M A_{ij} = 1 \quad \forall i \quad (4)$$

$$\sum_{i=1}^N A_{ij} B_{ik} \leq C \quad \forall jk \quad (5)$$

### 2.3 Behavior-Aware User Assignment Algorithm

Now at first let we think about a very simple version of the problem. As per today’s service provider’s commitment if all the client needs a fixed amount of bandwidth all the time then we can view it as a one-dimensional bin-packing problem. In this type of problem the bin size is the actual bandwidth limit of every wavelength and items size denotes the client’s bandwidth request. Our main focus is to pack all the items by using minimum number of bins. The 1 DBP problem has been end up being a combinational NP-hard problem which is very useful here. For this purpose our client assignment problem shown as a two-dimensional variation (where the client bandwidth need not to be fixed till a function of time.) It is also a NP-hard problem. For this reasons most of the algorithms are used heuristically to get the better output. The output cannot be optimal.

Our heuristic approach is based on the depth-first tree searching technique. Firstly every client occupies a separate wavelength. So that the bandwidth demands profile of the client matches with the wavelength pattern usage. In each step our target is to combine two wavelengths into one so that the bandwidth limit of C is not exceeded. After the combination of the wavelength based on the usage pattern is actually the vector summation of those two original wavelengths. By using this method the algorithm will show a new output in every time when there are no wavelength is remain to combine. And the recent result will be recorded if the recent result shows the usage of at most wavelength which is actually better than the previous best result or output.

We know that the actual size of the search tree will grow up exponentially in the basis of the number of clients, so that if we search the whole tree, it will be not a scalable solution. To optimize the search by checking which part of the tree we need to search first and when we need to stop the searching process, an evaluation function and a lower bound is introduced. By using Evaluation function we can easily determine the actual benefit with assigning two groups of clients in an assigned wavelength. The client profile shows the *K*-dimensional vector. Our goal is to count the minimum number of “usage peak”, that’s why we will eliminate as much as usage peak. By using this combining method we can gain more, with some complementary client profiles. And by using vector distance we can demonstrate the unlike profiles in respect to each other. The distance will be small, if we found two client profiles which are almost same. We use square vector distance for our evaluation function.

This evaluation function, however, tends to place too much focus on users whose profiles are big, so it is not the right strategy at all times, as seen in Fig. 4, in which as we try to combine two independent business clients with the same residential client. User E1 appears to pick the one with a greater magnitude. While the one with a smaller scale does a great job of extracting the “peak” Therefore, we still need to understand the form of the

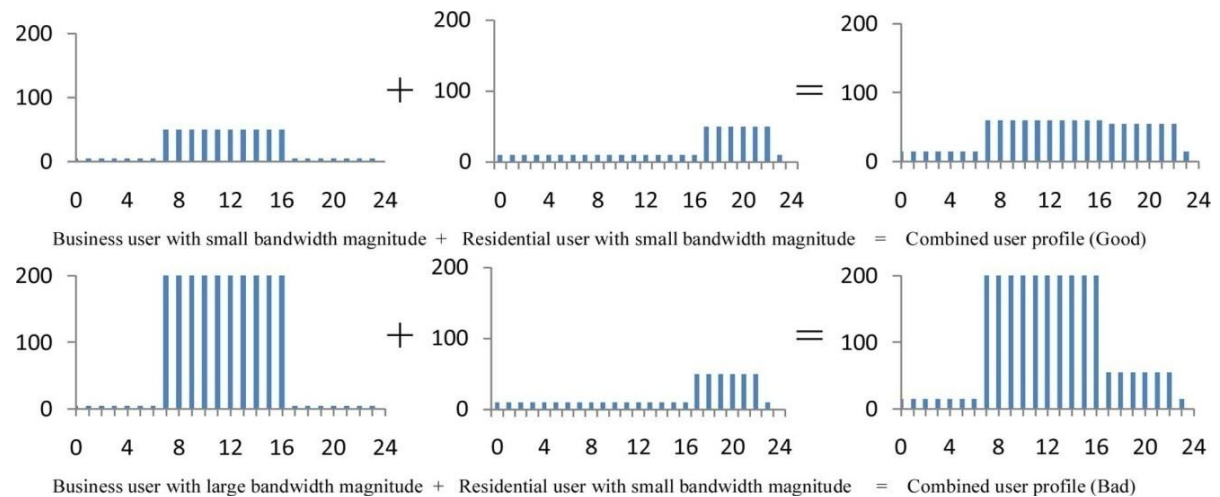

**Figure 4.** E<sub>1</sub> tends to provide advantage to profile with greater magnitude when combining as it evaluate the absolute value.

profiles instead of relying on distance alone. Evaluation functions E<sub>2</sub>, E<sub>3</sub> and E<sub>4</sub>, Therefore, and below, following this concept, are created; and our studies would later explain their benefits and limitations.

$$E_1(i, j) = \sum_{k=1}^K (B_{ik} - B_{jk})^2 \quad (6)$$



$$E_2(i, j) = \frac{\sqrt{\sum_{k=1}^K (B_{ik} - B_{jk})^2}}{\sqrt{\sum_{k=1}^K B_{ik}^2} \sqrt{\sum_{k=1}^K B_{jk}^2}} \quad (7)$$

$$E_3(i, j) = \sum_{k=1}^K \left( \frac{B_{ik}}{\sqrt{\sum_{k=1}^K B_{ik}^2}} - \frac{B_{jk}}{\sqrt{\sum_{k=1}^K B_{jk}^2}} B_{jk} \right)^2 \quad (8)$$

$$E_4(i, j) = \sum_{k=1}^K \left( \frac{B_{ik}}{\text{Max}_i \{B_{ik}\}} - \frac{B_{jk}}{\text{Max}_j \{B_{jk}\}} B_{jk} \right)^2 \quad (9)$$

To determine the proximity of the present outcome to the desired result, a lower bound is used. The desired outcome should, clearly, be between the lower bound and the actual outcome. If the current outcome is too close to the lower limit, searching could thus be avoided. The following is a simple lower bound L.

$$L = \text{Max}_k \left[ \sum_{i=1}^N \left( \frac{B_{ik}}{c} \right) \right] \quad (10)$$

But it is also possible to establish tighter lower bounds.

### III. USER ASSIGNMENT FOR ‘RING AND SPUR’ PON SYSTEM

#### 3.1 Problem Statement

Although our behavior-conscious client assignment method in such a "tree-and-branch" PON, Segment II could be deployed, often developed in densely populous metro cities, it is not appropriate for the "ring-and-spur" PON, which is a great broadband option for regions where more residents and enterprises are loosely clustered in industrial areas and small towns. Unlike its alternative, the "ring-and-spur" architecture typically has not only one, but several RNs in order to cover several residential areas and small towns in one PON. There is a distinct network section for each RN, which may consist of hundreds or thousands of clients covered by one of several wavelengths fallen from the specific RN. This means we are not able to select openly the network section for each client.

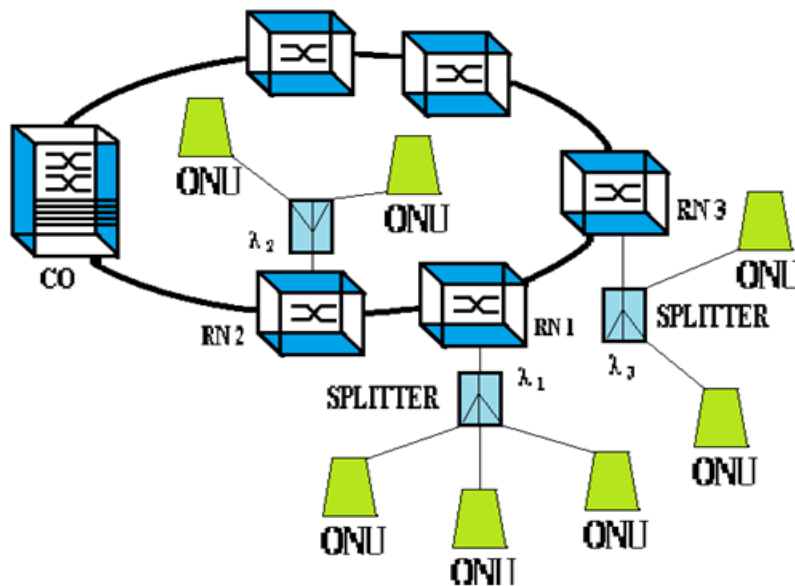

Figure 5. Wavelength sharing among different segment of the “ring-and-spur” PON.

Nevertheless, it is possible to construct a "ring-and-spur" PON that requires several network segments to share one wavelength under different RNs, so we can also minimize the number of wavelengths needed and save bandwidth by assigning clients with complementary profiles under different RNs to one wavelength. The "drop-and-continue" optical add-drop multiplexer (OADM) instead of the "drop-and-add" OADM (the former is much simpler to develop) could be used to do this wavelength-sharing feature if the RN is OADM-based, or more simply, add a coupler after the de-multiplexer (DeMux) and direct component. If the RN is Demux-based, the control goes back to the ring.

Consider a basic illustration described in Fig. 5. RN1 and RN3 are two suburban districts that each need around 8 Gbps of bandwidth at night at their peak hours, and RN2 is a commercial district that during business hours demands 15 Gbps at peak. We need to deploy four 10 Gbps wavelengths (one each for RN1 and RN3, two for RN2) without taking into account user actions, or we may share a separate wavelength for both RN1 and RN3, reducing the total number of wavelengths to two while also satisfying all the criteria for bandwidth. In addition to the limitations that clients are unable to freely pick network segments, this expanded

behavior-aware device assignment scheme has several other functional constraints. One of them is the RN problem of difficulty and control. As we have done, by having several wavelengths to decrease at one RN to achieve improved efficiency, this also makes the RN more costly that absorbs more energy.

### 3.2 Mathematical Model

Basically, with the following modifications, we may reuse the mathematical model which we built in Section II. In a 'ring and-spur' PON, let  $P$  denote the number of network segments and redefine  $M$  as the number of wavelengths used as  $P$  is no longer equal to  $M$ .  $A_{ij}$  is set to control whether wavelength  $J$  serves client  $i$  and  $D_{ij}$ , a fixed binary value, shows whether the client belongs to the network in  $j$  portion. Let  $L_j$  denote the amount of wavelengths required At  $RN_j$ , to be dropped.  $L_j$  can then be computed as:

$$L_i = \sum_{k=1}^M \frac{\sum_{l=1}^N A_{ik} D_{jk}}{N} \quad (11)$$

Since we are still minimizing  $M$  as our primary target, we still want to minimize  $L$ , where

$$L = \sum_{j=1}^P L_j \quad (12)$$

$L$  is the number of lowered wavelengths, collated over all RNs, which may be viewed in PON as a complication measure of RNs.

### 3.3 Revised Behavior-Aware User Assignment Algorithm

In order to fit the "ring-and-spur" design and promote the algorithm when we can experience broader networks, we also retain the search-based methodologies suggested in Section II with the following techniques applied. During the time of combining two users of the same network segment (or network segments that share wavelengths) should be given priority during the hunt, as this will minimize the number of wavelengths that need to be lowered at the RN. When we merge clients from various network segments into one wavelength, a group of network segments is created and cancelled when this wavelength becomes complete. In order to exploit the network segment group, we need to place clients in the same mutual wavelength, so it is likely that RN2 is in network segment groups of both RN1 and RN3 which do not belong to the network segment category (as was shown in Fig. 5). Recognition of patterns is used to make the process run quicker. As the evaluation function will be conducted during the quest at several periods, we will minimize the evaluation duration by simply accepting that the two users do not have comparable profiles, e.g. if their peak hours are about the same time.

## IV. BER PERFORMANCE EVALUATION

### 4.1 ONU-distance-aware (ODA) scheme with BER performance:

In this system, the designer first need to sort the ONUs according to their distance from the RN, and then assign the wavelength in sequence to the decreasing distance. During wavelength allocation it need to be considered that always allocate best possible wavelength for any RN, therefore an ONU could not be allocated a worse wavelength than that ONUs closer to the RN. The ODA system is able to measure BER between ONUs and helps to reduce variance as it compensates ONU situated at a far fields with better wavelength.[6]. The BER performance of any communication channel depends on the signal strength received at that point. In optical communication, the power received by any port of the communication link may be calculated as:

$$P_{sig}^i = L_f (d_{feeder} + d_{drop}^i) L_p L_s G P_t \quad (3)$$

Where  $P_{sig}^i$  is the signal power at the  $i$ -th port;

$L_f$  is the insertion loss at the feeder section

$L_p$  is the propagation loss per kilometre

$L_s$  is the loss at the drop section

distance of the feeder section

distance of the drop section for  $i$ -th port

$d_{feeder}$  is the  
 $d_{drop}^i$  is the  
 $G$  is the Gain  
 $P_t$  is the

transmission power

Noise variance for transmission of '0' and '1' are:

$$\sigma_0^2 = \sigma_{th 0}^2 + \sigma_{sh 0}^2 \quad (4)$$

$$\sigma_1^2 = \sigma_{th 1}^2 + \sigma_{sh 1}^2 \quad (5)$$

Where noise variance due to thermal noise is  $\sigma_{th}$ , and noise variance due to shot noise is  $\sigma_{sh}$ . The decision threshold set at the receiver end is:

$$I_{th} = \left[ \frac{R_{\lambda} P_{sig}^i \sigma_0 + \epsilon R_{\lambda} P_{sig}^i \sigma_1}{(\sigma_0 + \sigma_1)} \right] \quad (6)$$

Where  $R_{\lambda}$  is the photo-detector responsivity ( $R_{\lambda} = 0.8$ ) and  $\epsilon$  is the laser extinction ratio ( $\epsilon = 0.1$ ). Then the BER at the receiver end may be computed as follow:

$$BER = \frac{1}{4} \left\{ \begin{aligned} &erfc \left[ \frac{R_{\lambda} P_{sig}^i - I_{th}}{\sqrt{2}\sigma_1} \right] + \\ &+ erfc \left[ \frac{I_{th} - \epsilon R_{\lambda} P_{sig}^i}{\sqrt{2}\sigma_0} \right] \end{aligned} \right\} \quad (7)$$

This technique is useful to find out the BER performance of the between CO to the splitter with subsequent ONUs.

### V. ILLUSTRATIVE NUMERICAL EXAMPLE WITH SIMULATION RESULTS

The data set for our numerical examples on “tree-and-spur” PON consists with more than 150 independent users which were classed into two groups: business user group and residential user group. The user profile was defined as an array of 24 elements, which represent the user’s bandwidth needs for each of the 24 h of a day. Each profile were possible to be further divided into two time periods as peak and off-peak during which the bandwidth needs were normally distributed but having different means and variances.

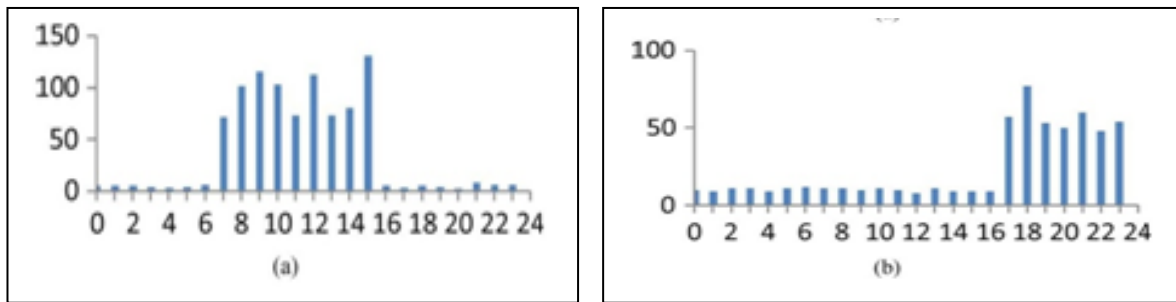

Figure 6. Samples of (a) business user profile and (b) residential user profile.

The mean bandwidth was set to 100 Mbps/5 Mbps for business users and 50 Mbps/10 Mbps for residential users during peak/off-peak hours. The standard deviation is set to 20 Mbps/1 Mbps for both kinds of users during peak/off-peak. All the normal distributions were truncated between 0 and two times of mean in order to keep all the data non-negative. The start time and end times of a peak also followed the normal distributions. Typical samples of business user profile and residential user profile are shown in Fig. 6. In this examples that we are discussing, bandwidth per wavelength were set to 2.5 and 1 Gbps (consistent with current PON standards) and we need to determine the minimum number of wavelengths to accommodate all users’ bandwidth requirements.

Then the focus of interest was on the ratio between number of business users and residential users. We vary the ratio from 10%:90% to 90%:10%, in increments of 10%. We note that the four evaluation functions differ significantly in dealing with different compositions of users.  $E_1$  tends to provide better results when one kind of users is dominant in the data set, while the other three functions tend to perform better otherwise, as shown in Figs. 7 and 8. (Since the performances of  $E_2$ ,  $E_3$  and  $E_4$  are almost the same, only the  $E_4$  performance is shown in these two figures.) The reason for this phenomenon is that function  $E_1$  can be computed more quickly than the other three functions, so it can search the tree more thoroughly than the other three methods for a given amount of time (using a Pentium-5 PC with 2.8-GHz CPU, and 4-GB memory in our case). On the other hand, the other evaluation functions yield a quicker path to find an approximate solution, so they are more suitable when the combination of user profiles is complex. A larger example carried over the “ring-and-spur” PON also confirm that the behavior-aware user assignment scheme could accommodate all the bandwidth demands with less number of wave- lengths needed and thus saves both energy and cost shown in Fig 9.



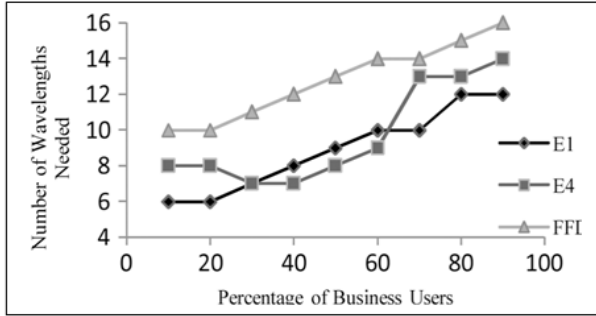

Figure. 7. No of wavelengths required 2.5 Gbps/λ.

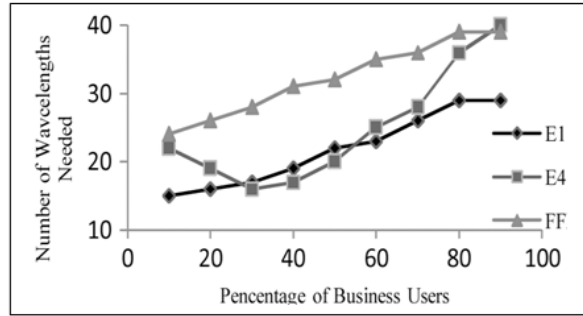

Figure. 8. No of wavelengths required 1 Gbps/λ.

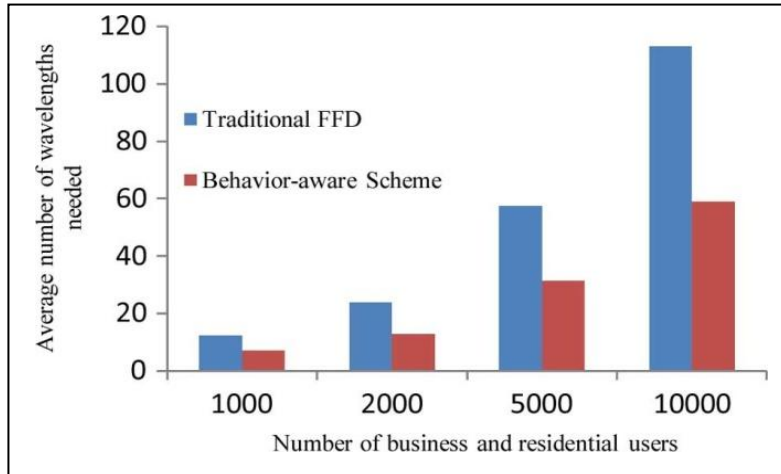

Figure. 9 Behavior-aware user assignment schemes use fewer wavelengths than traditional methods.

Now the BER calculation needs to be carried for each ONU to CO connection path. So here BER performance for upstream direction data flow need to be computed for different distance (D) with different transmitting power (Tx) vs BER. Some sample results are:

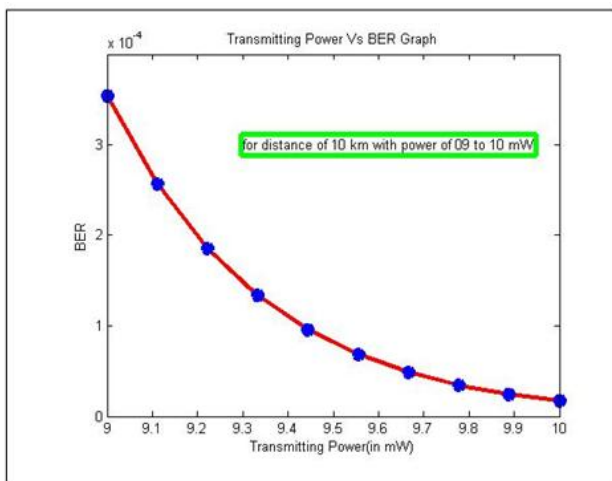

Figure 10 (a): D= 10 km; Tx= 09 to 10 mw

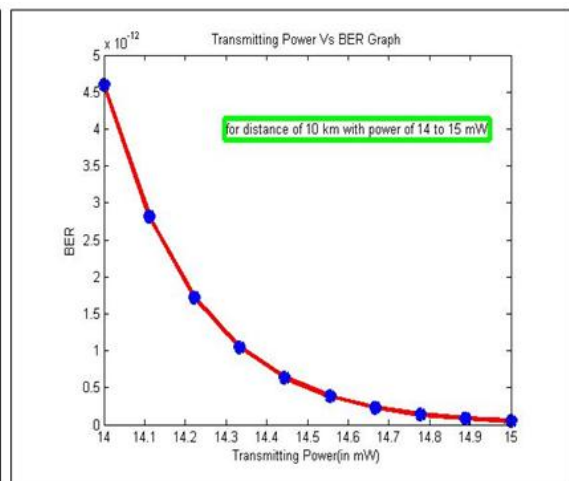

Figure 10 (b): D=:10 km; Tx=14 to 15 mw

From the Fig. 10 it is seen that the BER evaluation becomes less for two different cases where we are transmitting signals for same distances of 10 km but with different transmitting power. The signals were transmitted through optical cable. For higher transmission power, the BER got lowered.

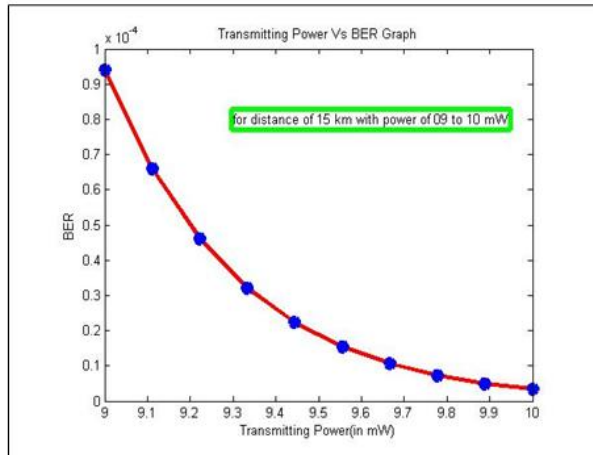

Figure 10 (c): D= 15 km; Tx= 09 to 10 mw

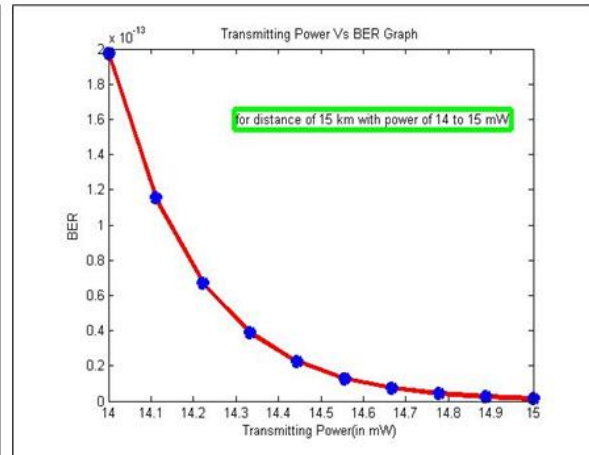

Figure 10 (d): D=:15 km; Tx=14 to 15 mw

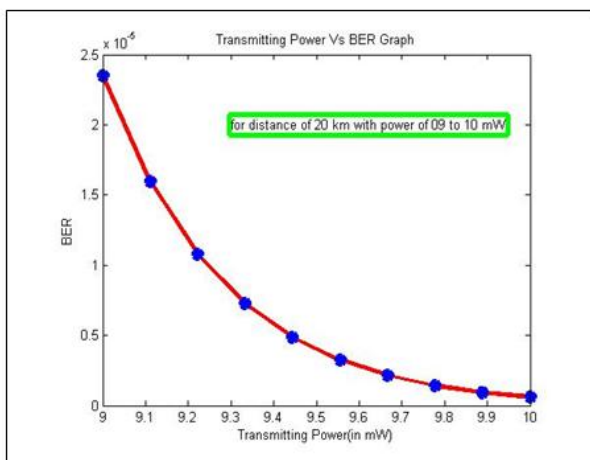

Figure 10 (e): D= 20 km; Tx= 09 to 10 mw

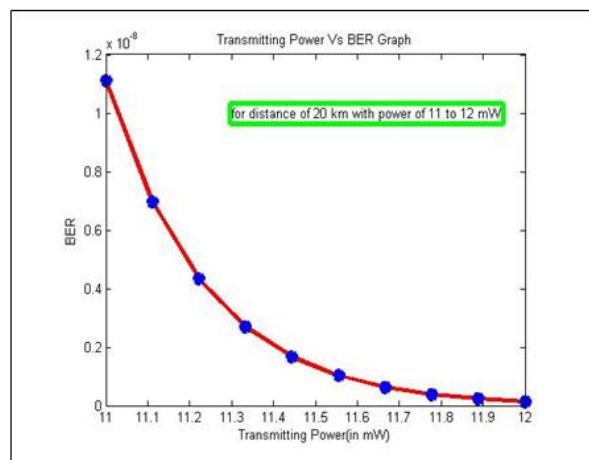

Figure 10 (f): D=:20 km; Tx=14 to 15 mw

From the above six results (Figure 6(a) to 6(f)) of BER performance evaluation, this is evident that for longer distance (D) we need to employ more Transmission Power (Tx) to achieve lower BER figure. So by calculating the BER performance, the wavelength allocation may be done for the communicating line from CO to ONU and vice versa.

## VI. CONCLUSION

With consideration of different network usage behaviors of the users (i.e., the daily bandwidth demand profiles of the customers), we may assign group to the users (e.g., business and residential users) for efficient allocation of wavelengths in PONs with “tree-and-branch” or “ring-and-spur” topologies of networking and further based on the BER evaluation of the customer it is possible to achieve high network utilization at all times. The behavior aware user assignment followed by BER evaluation based wavelength allocation approach achieves a significant improvement over data communication through PON system.

## ACKNOWLEDGEMENT

We are thankful to our college authority and the JIS Group as a whole, for their untiring support for our work with Passive Optical Network (PON) system.

## REFERENCE

- [1]. R. P. Davey, D. B. Payne, D. Nasset, P. Tomlinson, T. Gilfedder, P. Chidgey, and A. Rafel, “Long-reach access and future broadband net- work economics,” in *Proc. 33rd Eur. Conf. and Exhib. on Optical Com- munications (ECOC’07)*, Berlin, Germany, Sep. 2007.
- [2]. K. J. Christensen, C. Gunaratne, B. Nordman, and A. D. George, “The next frontier for communications networks: Power management,” *Comput. Commun.*, vol. 27, pp. 1758–1770, 2004.
- [3]. C. Lange and A. Gladisch, “On the energy consumption of FTTH access networks,” in *Proc. IEEE/OSA Optical Fiber Communication Conf. 2009 (OFC 2009)*, San Diego, CA, Mar. 2009.
- [4]. J. Baliga, R. Ayre, W. V. Sorin, K. Hinton, and R. S. Tucker, “Energy consumption in access networks,” in *Proc. IEEE/OSA*

- Optical Fiber Communication Conf. 2008 (OFC 2008)*, San Diego, Mar. 2008.
- [5]. G. Keiser, *Optical Fiber Communications*. New York: McGraw-Hill, 2000.
  - [6]. J Pandit, S. K. Biswas, "Path Optimization and Cost Estimation using algorithm for sub optimal deployment of Passive Optical Network" presented at ICCECE International Conference, Kolkata (2017).
  - [7]. K Satyanarayana, "Recent trends in future proof fiber access passive networks: GPON and WDM PON," 2014 International Conference on Recent Trends in Information Technology 10-12 April 2014
  - [8]. M. Abrams, P. C. Becker, Y. Fujimoto, V. O. Byrne, and D. Piehler, "FTTP Deployments in the United States and Japan – Equipment Choices and Service Provider Imperatives," *IEEE Journal of Lightwave Technology*, vol. 23, pp. 236-246, (2005).
  - [9]. M.J. Rattigan, M. Maier, and D. Jensen, "Graph Clustering with Network Structure Indices," in Proc. 24th Annual International Conference on Machine Learning (ICML'07), (2007).
  - [10]. S. K. Biswas, M. Chakraborty "Passive Optical Network Design with application of Path Minimization Planning and Novel Wavelength Allocation scheme based on Bit Error Rate (BER) Performance," *International Journal of Engineering Research and Application*, ISSN: 2248-9622, Vol. 10, Issue 10, (Series-IV) October 2020, pp. 08-14 (2020).
  - [11]. S. K. Biswas, A. Podder, "Path Minimization Planning of Passive Optical Network using Algorithm for Sub-optimal Deployment of Passive Optical Network", *International Research Journal of Engineering and Technology*, Vol. 7, No. 9, pp.3484-3488 (September 2020).
  - [12]. YU Nakyama & Ryoma Yasunaga, "ITU TWDM-PON module for ns-3," *Wireless Networks 2020*, Vol. 4, No. 5, pp.532-533 (May 2020).
  - [13]. Y Ji, J Zhang, X Wang, H Yu, "Towards converged, collaborative and co-automatic (3C)" *Optical Networks Science*, vol. 61, pp. 101-119, (2018).

Satyaki Kumar Biswas, Ali, et. al. "Energy-Efficient Passive Optical Network (PON) Planning with Wavelength Allocation Scheme based on User Behaviors and Bit Error Rate (BER) Performance Evaluation." *International Journal of Engineering Science Invention (IJESI)*, Vol. 10(02), 2021, PP 01-11. Journal DOI- 10.35629/6734